

FEATURES

- Double Side Cooling
- High Surge Capability

APPLICATIONS

- Crowbar
- High Power Drives
- High Voltage Power Supplies
- Static Switches

VOLTAGE RATINGS

Part and Ordering Number	Repetitive Peak Voltages V_{DRM} and V_{RRM} (V)	Conditions
DCR3360A65*	6500	$T_{vj} = -40^{\circ}\text{C}$ to 125°C , $I_{DRM} = I_{RRM} = 300\text{mA}$, $V_{DRM}, V_{RRM} t_p = 10\text{ms}$ $V_{DSM} \& V_{RSM} =$ $V_{DRM} \& V_{RRM} + 100\text{V}$ respectively
DCR3360A60	6000	
DCR3360A55	5500	

Lower voltage grades available.

*6200V @ -40°C , 6500V @ 0°C

KEY PARAMETERS

V_{DRM}	6500V
$I_{T(AV)}$	3360A
I_{TSM}	44700A
dV/dt^*	2000V/μs
dI/dt	500A/μs

* Higher dV/dt selections are available on request

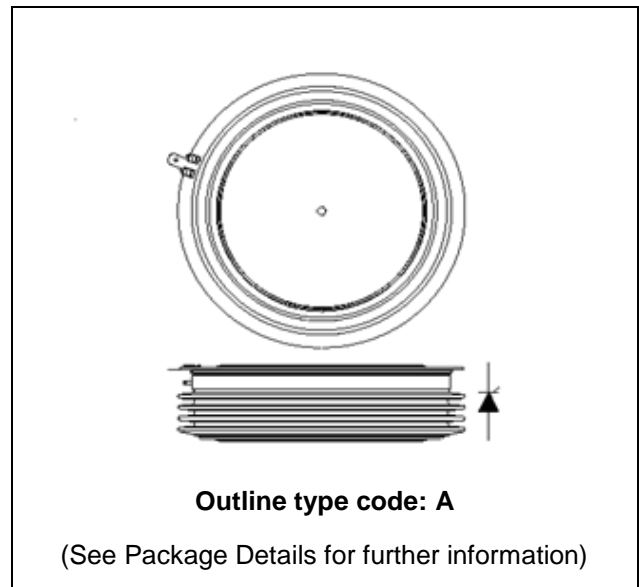

Fig. 1 Package outline

ORDERING INFORMATION

When ordering, select the required part number shown in the Voltage Ratings selection table.

For example:

DCR3360A65

Note: Please use the complete part number when ordering and quote this number in any future correspondence relating to your order.

CURRENT RATINGS

$T_{case} = 60^{\circ}C$ unless stated otherwise

Symbol	Parameter	Test Conditions	Max.	Units
Double Side Cooled				
$I_{T(AV)}$	Mean on-state current	Half wave resistive load	3360	A
$I_{T(RMS)}$	RMS value	-	5280	A
I_r	Continuous (direct) on-state current	-	4840	A

SURGE RATINGS

Symbol	Parameter	Test Conditions	Max.	Units
I_{TSM}	Surge (non-repetitive) on-state current	10ms half sine, $T_{case} = 125^{\circ}C$ $V_R = 0$	44.7	kA
I^2t	I^2t for fusing		9.99	MA ² s

THERMAL AND MECHANICAL RATINGS

Symbol	Parameter	Test Conditions		Min.	Max.	Units
$R_{th(j-c)}$	Thermal resistance - junction to case	Double side cooled	DC	-	6.0	$^{\circ}C/kW$
		Single side cooled	Anode DC	-	10.4	$^{\circ}C/kW$
			Cathode DC	-	14.9	$^{\circ}C/kW$
$R_{th(c-h)}$	Thermal resistance - case to heatsink	Clamping force 83kN (with mounting compound)	Double side	-	1.0	$^{\circ}C/kW$
			Single side	-	2.0	$^{\circ}C/kW$
T_{vj}	Virtual junction temperature	Blocking V_{DRM} / V_{RRM}		-	125	$^{\circ}C$
T_{stg}	Storage temperature range			-55	125	$^{\circ}C$
F_m	Clamping force			74	91	kN

DYNAMIC CHARACTERISTICS

Symbol	Parameter	Test Conditions	Typ.	Max.	Units
I_{RRM}/I_{DRM}	Peak reverse and off-state current	At V_{RRM}/V_{DRM} , $T_{case} = 125^{\circ}C$	-	300	mA
		At 50% V_{RRM}/V_{DRM} , $T_{case} = 125^{\circ}C$	20	-	mA

Symbol	Parameter	Test Conditions	Min.	Max.	Units	
V_{TM}	Instantaneous forward voltage	At 4000A peak, $T_j = 125^{\circ}C$	1.80	2.05	V	
dV/dt	Max. linear rate of rise of off-state voltage	To 67% V_{DRM} , $T_j = 125^{\circ}C$, gate open	-	2000	V/ μ s	
dI/dt	Rate of rise of on-state current	From 67% V_{DRM} to $2x I_{T(AV)}$ Gate source 30V, 10 Ω $t_r < 0.5\mu$ s, $T_j = 125^{\circ}C$	Repetitive 50Hz	-	200	A/ μ s
			Non-repetitive	-	500	A/ μ s
V_{T(ro)}	Threshold voltage - Low level	500A to 3300A at $T_{case} = 125^{\circ}C$	-	0.93	V	
	Threshold voltage - High level	3300A to 9000A at $T_{case} = 125^{\circ}C$	-	1.16	V	
r_T	On-state slope resistance - Low level	500A to 3300A at $T_{case} = 125^{\circ}C$	-	0.29	m Ω	
	On-state slope resistance - High level	3300A to 9000A at $T_{case} = 125^{\circ}C$	-	0.22	m Ω	
t_{gd}	Delay time	$V_D = 67\% V_{DRM}$, gate source 30V, 10 Ω $t_r = 0.5\mu$ s, $T_j = 25^{\circ}C$	-	3	μ s	
t_q	Turn-off time	$I_T = 3000A$, $T_j = 125^{\circ}C$, $V_R = 200V$, $dI/dt = 1A/\mu$ s, $dV_{DR}/dt = 20V/\mu$ s linear	-	500	μ s	
Q_s	Stored charge	$I_T = 1500A$, $T_j = 125^{\circ}C$, $dI/dt = 1A/\mu$ s	4540	8620	μ C	
I_{RR}	Reverse recovery current	$V_R \sim 2600V$, $C_s = 1\mu$ F, $R_s = 63\Omega$	56	80	A	
I_L	Latching current	$T_j = 25^{\circ}C$, $V_D = 5V$	-	3	A	
I_H	Holding current	$T_j = 25^{\circ}C$, $R_{G-K} = \infty$, $I_{TM} = 500A$, $I_T = 5A$	-	300	mA	

GATE TRIGGER CHARACTERISTICS AND RATINGS

Symbol	Parameter	Test Conditions	Max.	Units
V _{GT}	Gate trigger voltage	V _{DRM} = 5V, T _{case} = 25°C	1.5	V
V _{GD}	Gate non-trigger voltage	At 50% V _{DRM} , T _{case} = 125°C	0.4	V
I _{GT}	Gate trigger current	V _{DRM} = 5V, T _{case} = 25°C	400	mA
I _{GD}	Gate non-trigger current	At 50% V _{DRM} , T _{case} = 125°C	10	mA

CURVES

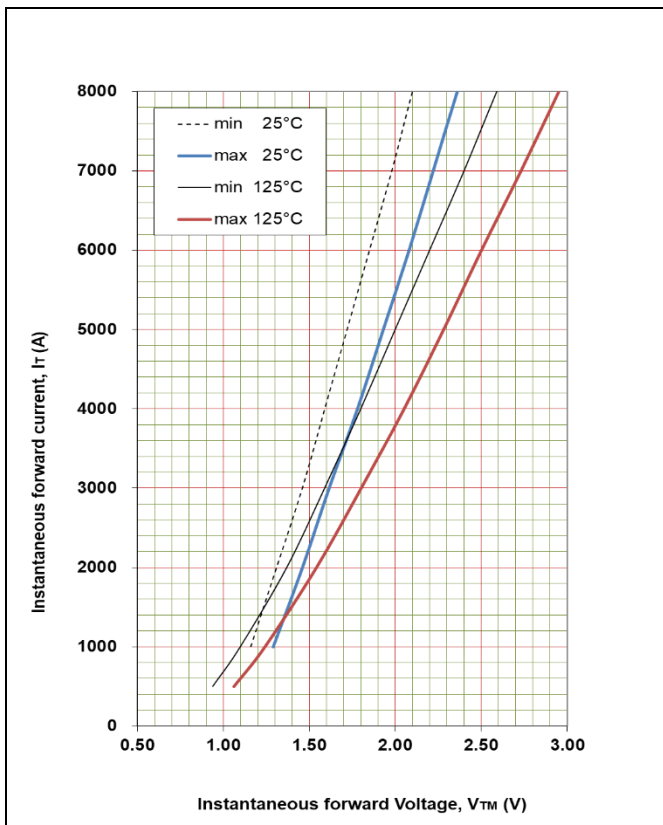

Fig. 2 Maximum & minimum on-state characteristics

V_{TM} EQUATION

$$V_{TM} = A + B \cdot \ln(I_T) + C \cdot I_T + D \cdot \sqrt{I_T}$$

Where A = -0.632454
 B = 0.283028
 C = 0.000246
 D = -0.010394

These values are valid for T_j = 125°C for I_T 500A to 9000A

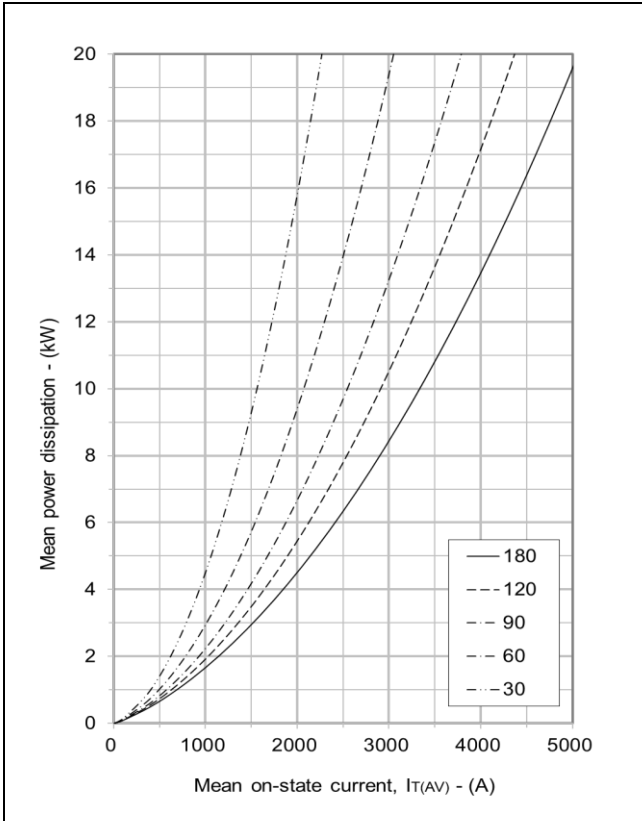

Fig. 3 On-state power dissipation - sine wave

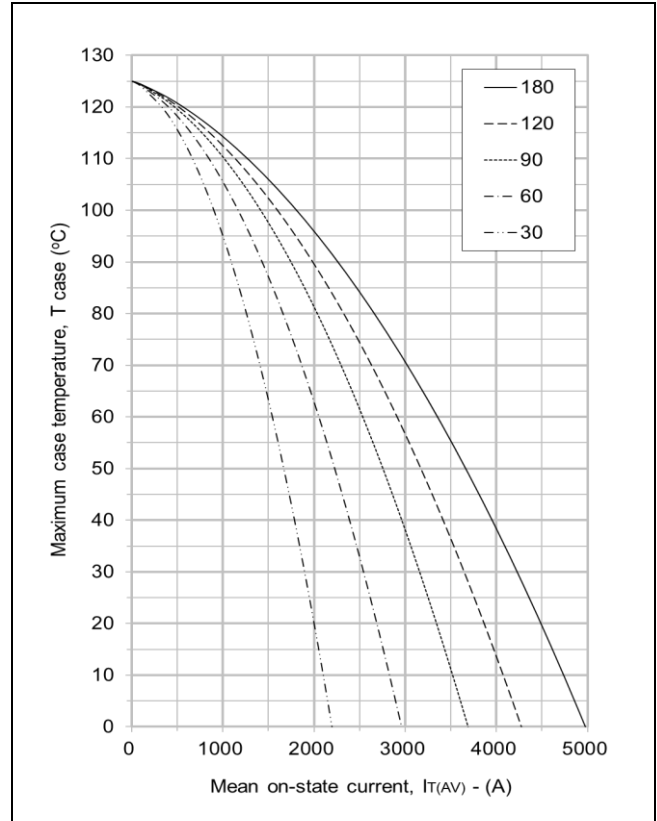

Fig. 4 Maximum permissible case temperature, double side cooled - sine wave

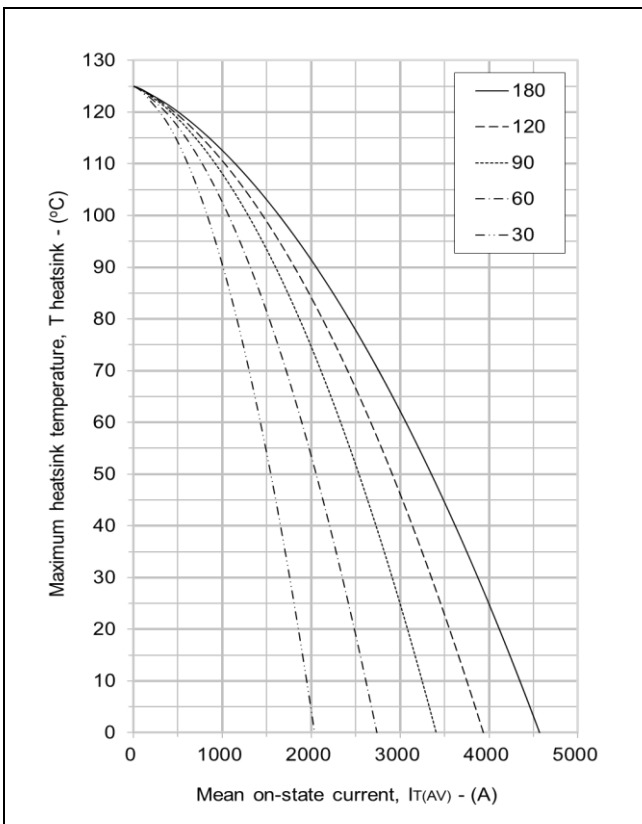

Fig. 5 Maximum permissible heatsink temperature, double side cooled - sine wave

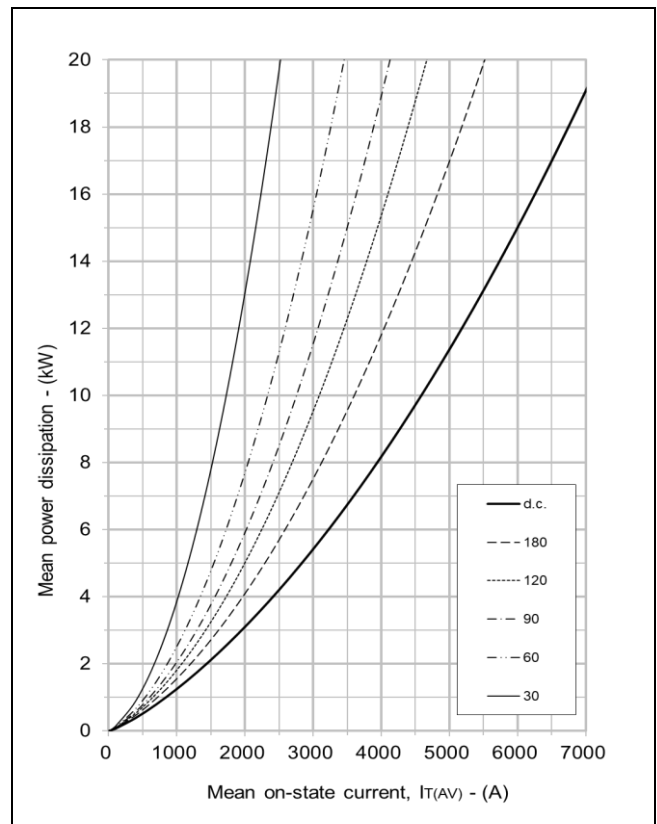

Fig. 6 On-state power dissipation - rectangular wave

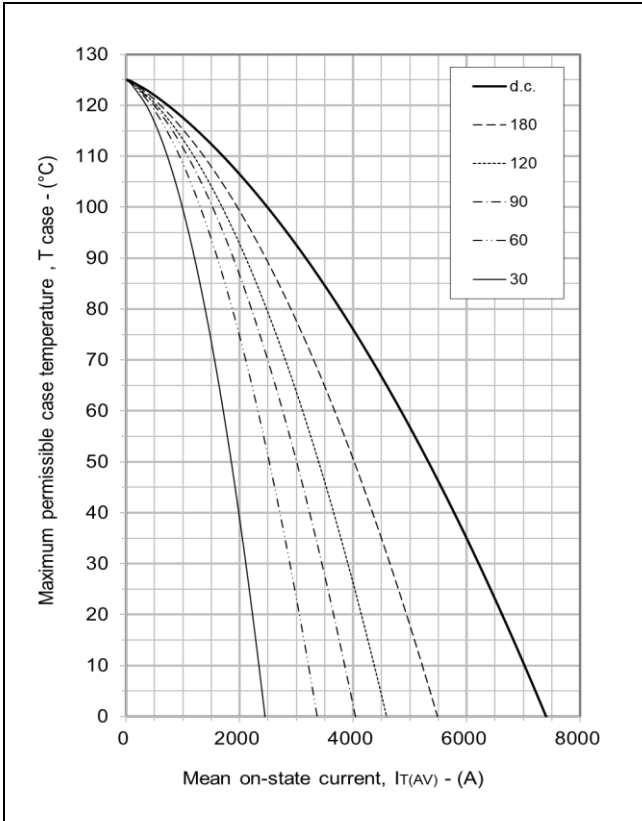

Fig. 7 Maximum permissible case temperature, double side cooled - rectangular wave

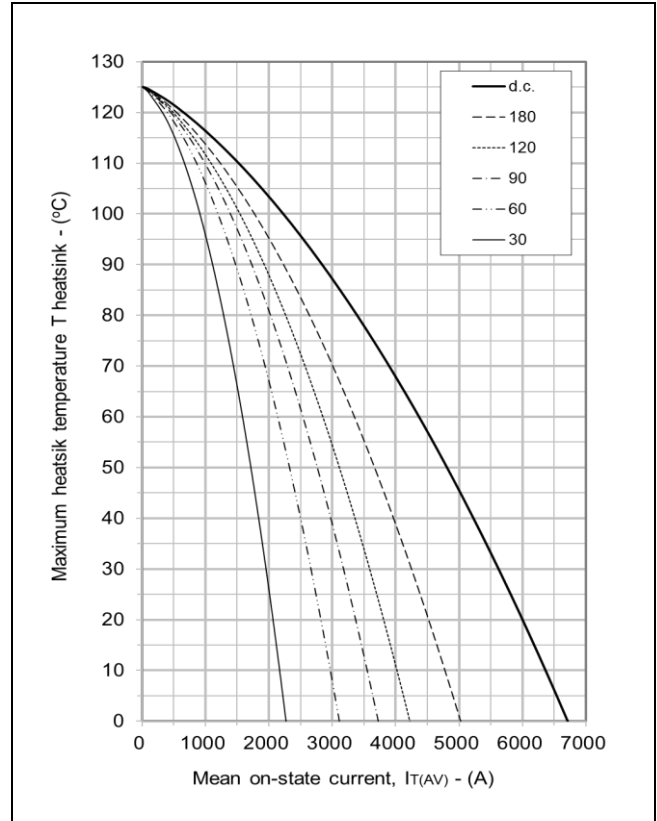

Fig. 8 Maximum permissible heatsink temperature, double side cooled - rectangular wave

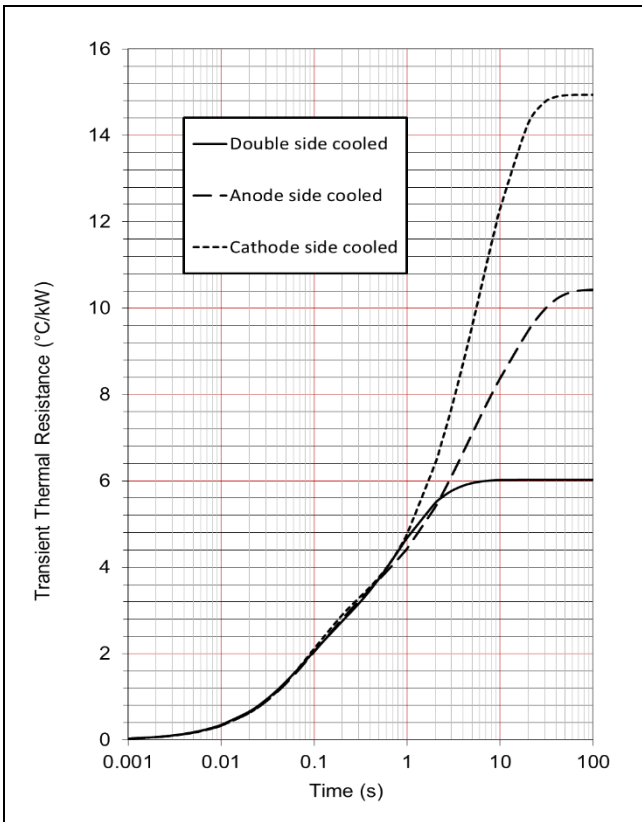

Fig.9 Maximum (limit) transient thermal impedance – junction to case (degC/kW)

		1	2	3	4
Double side cooled	Ri(°C/kW)	3.015	1.049	0.984	0.984
	Ti(s)	0.704	1.905	0.059	0.059
Anode side cooled	Ri(°C/kW)	3.156	4.093	1.557	1.624
	Ti(s)	2.690	13.792	0.059	0.206
Cathode side cooled	Ri(°C/kW)	7.077	3.483	1.746	2.634
	Ti(s)	6.649	8.436	1.762	0.081

$$Z_{th} = \sum_{i=1}^{i=4} R_i \cdot \left(1 - \exp\left(-\frac{T}{T_i}\right)\right)$$

$\Delta R_{th(j-c)}$ Conduction

Tables show the increments of thermal resistance $R_{th(j-c)}$ when the device operates at conduction angles other than d.c.

Double side cooling			Anode Side Cooling			Cathode Sided Cooling		
θ°	$\Delta Z_{th} (z)$		θ°	$\Delta Z_{th} (z)$		θ°	$\Delta Z_{th} (z)$	
	sine.	rect.		sine.	rect.		sine.	rect.
180	0.44	0.31	180	0.42	0.30	180	0.42	0.30
120	0.49	0.43	120	0.47	0.41	120	0.47	0.41
90	0.55	0.49	90	0.52	0.46	90	0.52	0.46
60	0.60	0.55	60	0.57	0.52	60	0.57	0.52
30	0.64	0.61	30	0.61	0.58	30	0.60	0.58
15	0.66	0.64	15	0.62	0.61	15	0.62	0.60

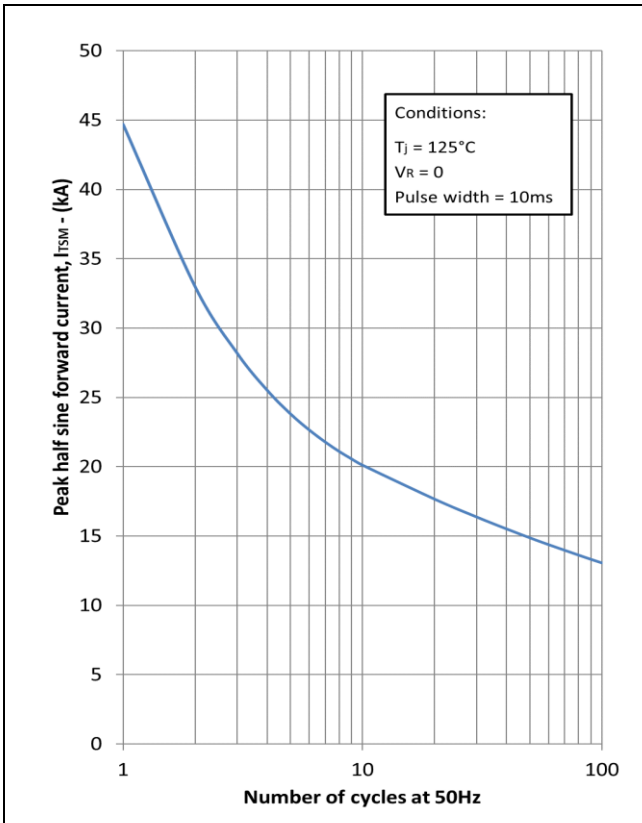

Fig. 10 Multi-cycle surge current

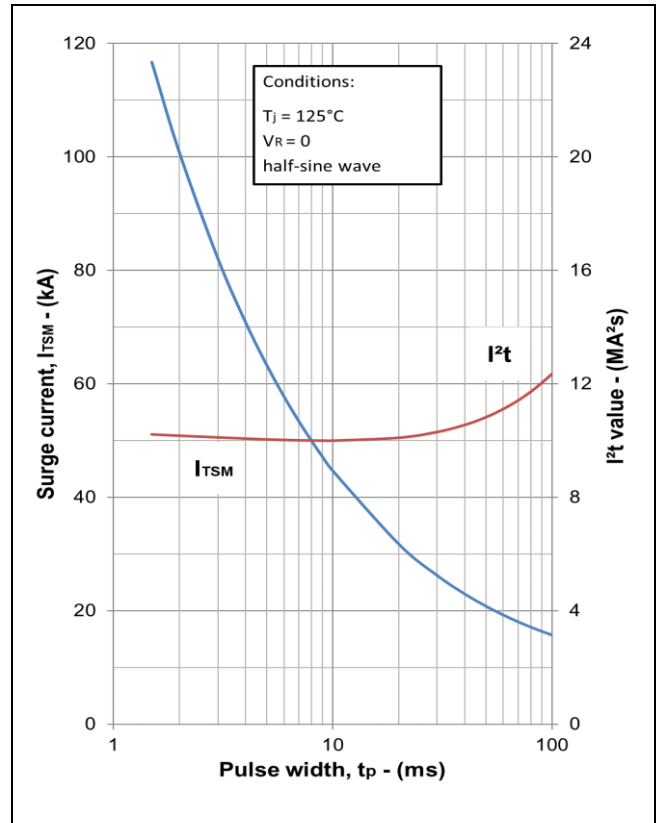

Fig. 11 Single-cycle surge current

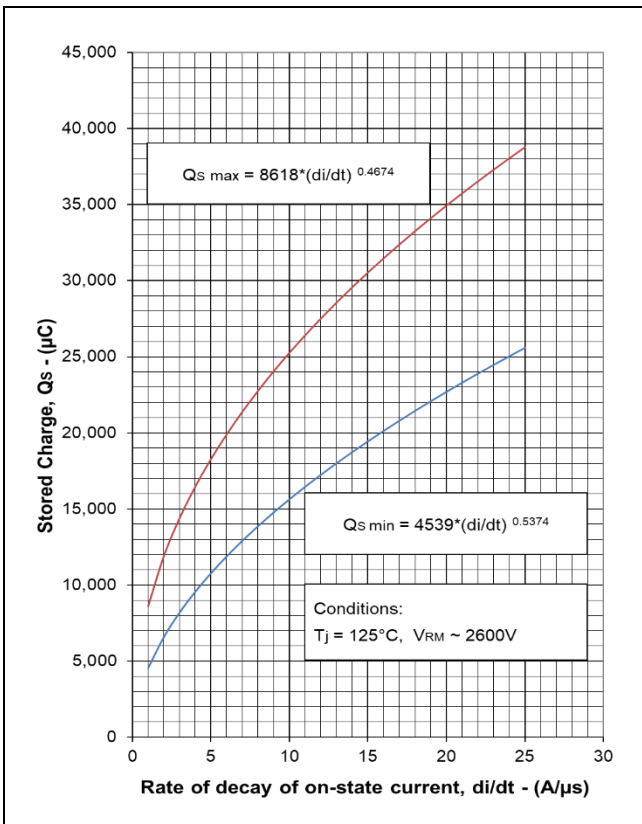

Fig. 12 Stored charge

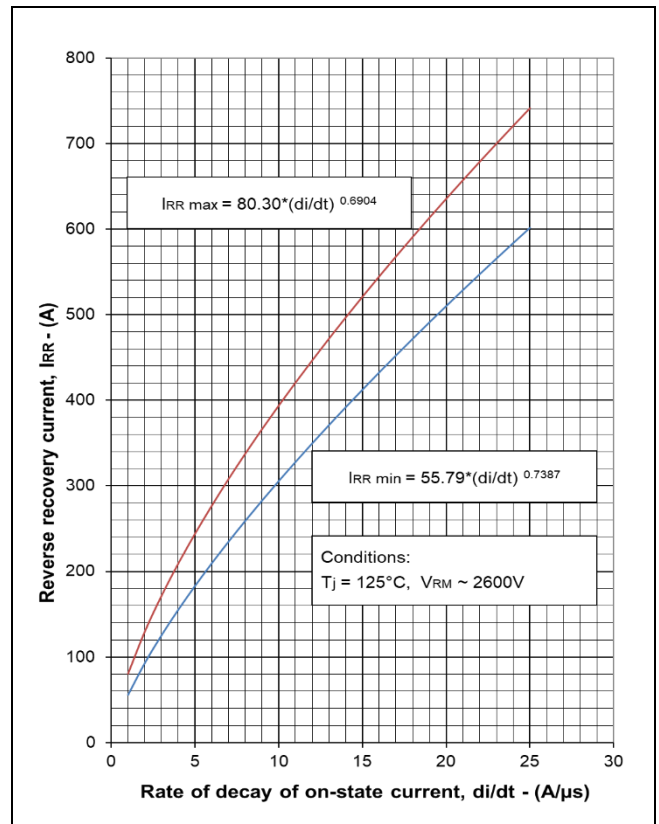

Fig. 13 Reverse recovery current

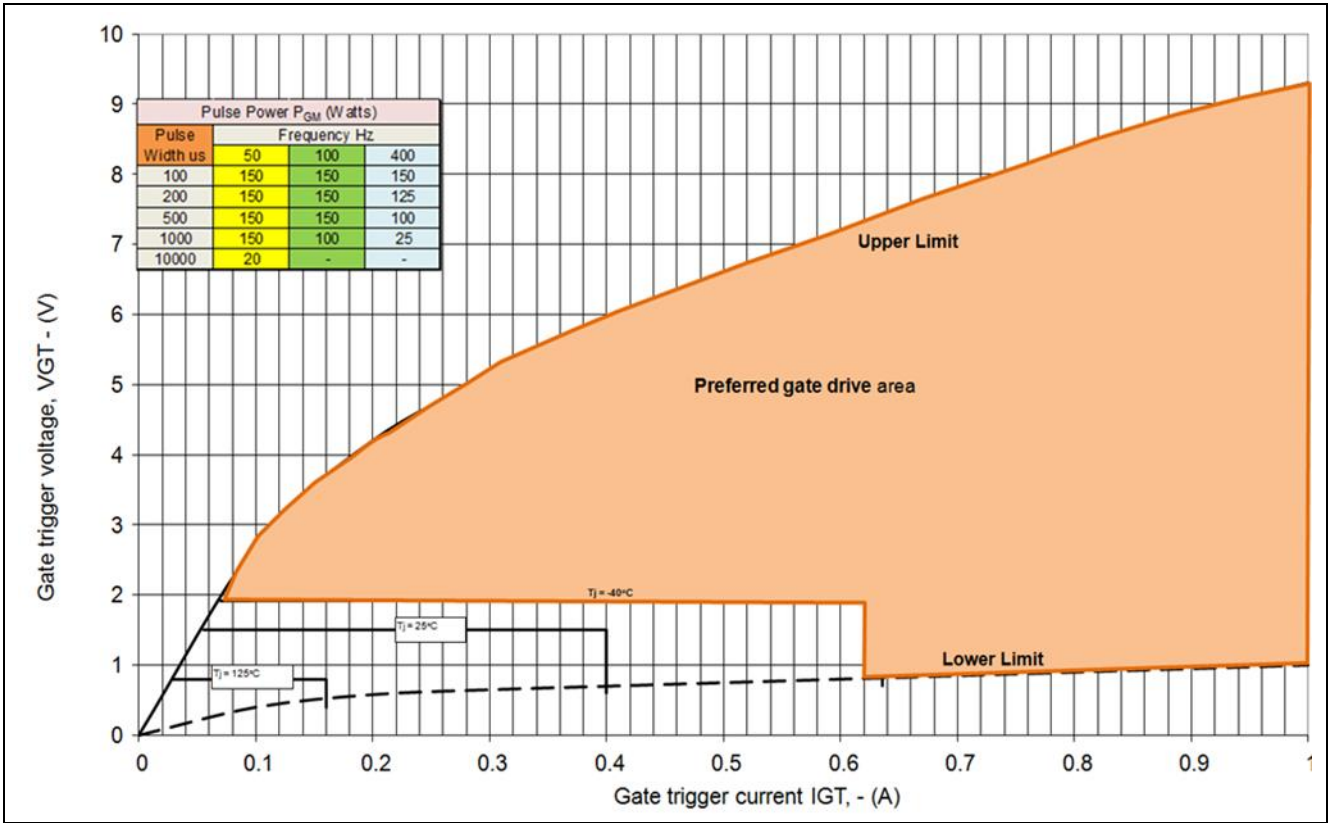

Fig.14 Gate characteristics

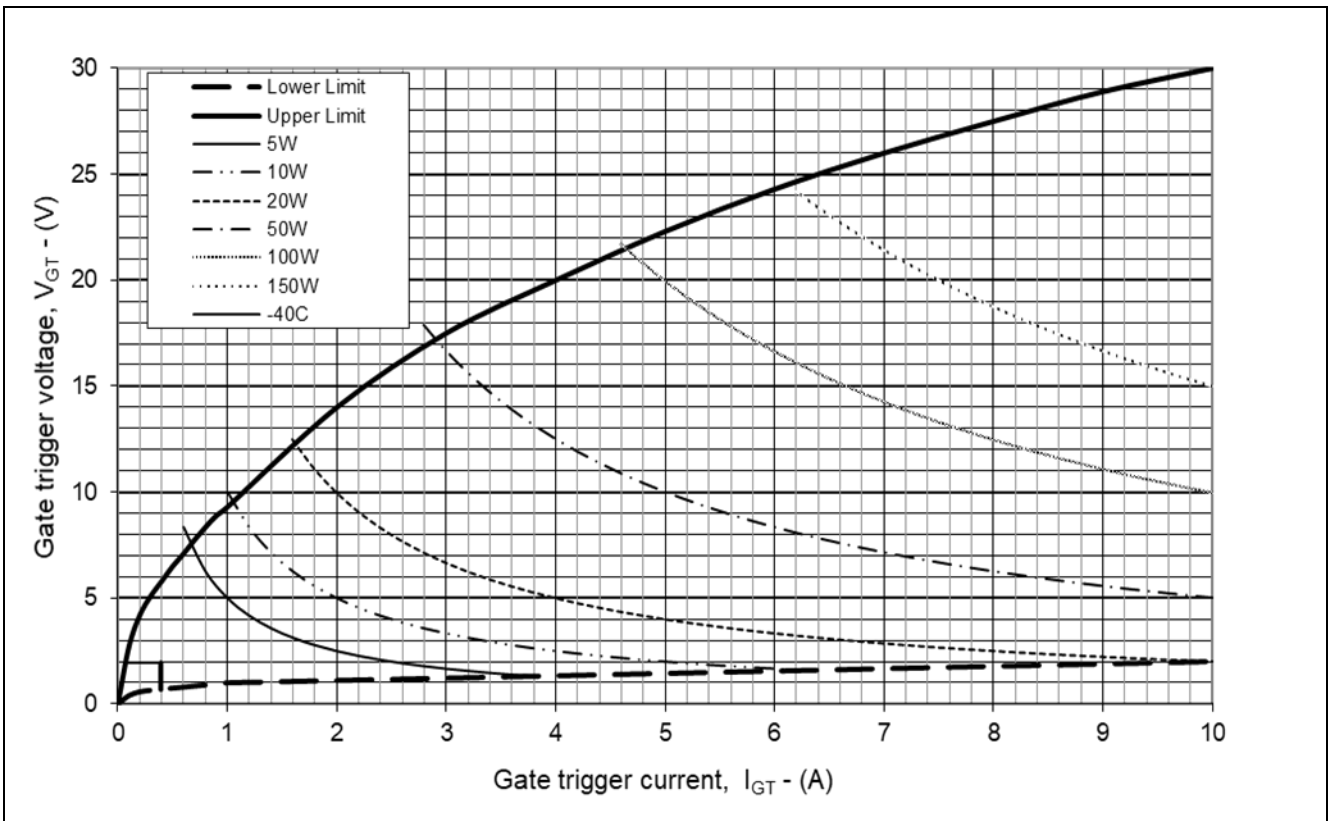

Fig. 15 Gate characteristics

PACKAGE DETAILS

For further package information, please contact Customer services.

All dimensions in mm, unless stated otherwise.

DO NOT SCALE

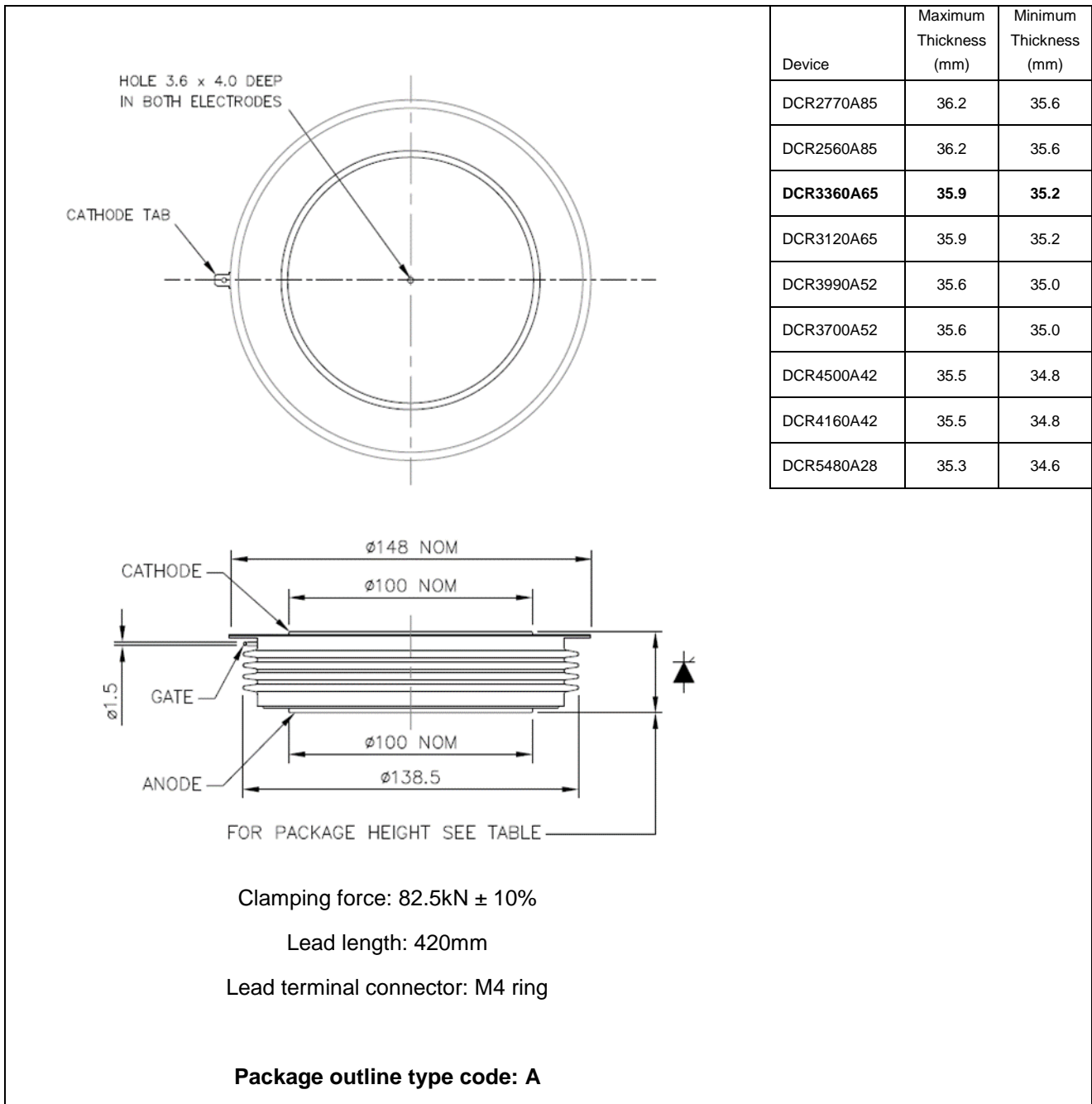

Fig. 16 Package outline

IMPORTANT INFORMATION:

This publication is provided for information only and not for resale.

The products and information in this publication are intended for use by appropriately trained technical personnel.

Due to the diversity of product applications, the information contained herein is provided as a general guide only and does not constitute any guarantee of suitability for use in a specific application. The user must evaluate the suitability of the product and the completeness of the product data for the application. The user is responsible for product selection and ensuring all safety and any warning requirements are met. Should additional product information be needed please contact Customer Service.

Although we have endeavoured to carefully compile the information in this publication it may contain inaccuracies or typographical errors. The information is provided without any warranty or guarantee of any kind.

This publication is an uncontrolled document and is subject to change without notice. When referring to it please ensure that it is the most up to date version and has not been superseded.

The products are not intended for use in applications where a failure or malfunction may cause loss of life, injury or damage to property. The user must ensure that appropriate safety precautions are taken to prevent or mitigate the consequences of a product failure or malfunction.

The products must not be touched when operating because there is a danger of electrocution or severe burning. Always use protective safety equipment such as appropriate shields for the product and wear safety glasses. Even when disconnected any electric charge remaining in the product must be discharged and allowed to cool before safe handling using protective gloves.

Extended exposure to conditions outside the product ratings may affect reliability leading to premature product failure. Use outside the product ratings is likely to cause permanent damage to the product. In extreme conditions, as with all semiconductors, this may include potentially hazardous rupture, a large current to flow or high voltage arcing, resulting in fire or explosion. Appropriate application design and safety precautions should always be followed to protect persons and property.

Product Status & Product Ordering:

We annotate datasheets in the top right hand corner of the front page, to indicate product status if it is not yet fully approved for production. The annotations are as follows:

Target Information:	This is the most tentative form of information and represents a very preliminary specification. No actual design work on the product has been started.
Provisional Information:	Some initial development work has been performed. The datasheet represents a view of the end product based on very limited information. Certain details will change.
Preliminary Information:	The product design is complete and final characterisation for volume production is in progress. The datasheet represents the product as it is now understood but details may change.
No Annotation:	The product has been approved for production and unless otherwise notified by Dynex any product ordered will be supplied to the current version of the data sheet prevailing at the time of our order acknowledgement.

All products and materials are sold and services provided subject to Dynex's conditions of sale, which are available on request.

Any brand names and product names used in this publication are trademarks, registered trademarks or trade names of their respective owners.

HEADQUARTERS OPERATIONS

DYNEX SEMICONDUCTOR LIMITED
Doddington Road, Lincoln, Lincolnshire. LN6 3LF
United Kingdom.
Phone: +44 (0) 1522 500500
Fax: +44 (0) 1522 500550
Web: <http://www.dynexsemi.com>

CUSTOMER SERVICE

Phone: +44 (0) 1522 502753 / 502901
e-mail: powersolutions@dynexsemi.com