



Power Semiconductor Product Guide 2019

Dynex Semiconductor has a rich history in the design, development and production of High Power Semiconductors and Power Assemblies.

Throughout the years, our products have been applied in projects that vary from Traction, Power Quality through HVDC, Renewable Energy production to helping science advance.

Contents

IGBT Modules	03
1200V IGBT Modules	
Choppers, Dual Switches and Single Switches	04
1700V IGBT Modules	
Bi-directional Switches, Choppers, Dual Switches, Half Bridges and Single Switches	04
3300V IGBT Modules	
Choppers, Dual Switches, Half Bridges and Single Switches	05
4500V IGBT Modules	
Choppers, Single Switches	06
6500V IGBT Modules	
Choppers, Single switches	06
Open Source	07
IGBT Press-pack	08
Custom IGBT Modules	09
Design Tool	10
FRD Modules	13
1200V FRD Modules	
Dual Diodes and Triple Diodes	14
1800V FRD Modules	
Dual Diodes and Triple Diodes	14
3300V FRD Modules	
Dual Diodes, Triple Diodes and Series Pair Diodes	14
4500V and 6500V FRD Modules	
Dual Diodes and Triple Diodes	15
Bipolar Thyristors	17
Phase Control Thyristors	18, 19
Gate Turn off Thyristors	20
Asymmetric Bypass Thyristors	20
Pulsed Power Thyristors	21
Rectifier Diodes	23, 24
Fast Recovery Diodes	24
Flat Base Rectifier Diode	25
Explanation of Part Numbers	26
Package Outlines	27
IGBT Modules	29, 30
FRD Modules	31
Thyristors and Diodes	32
GTO	33
Symbols and Definitions	34
Important Information	36



IGBT Modules

Power Cycling with the latest generation IGBT die

The Dynex manufacturing plant is a vertically integrated facility with device design, wafer fab, packaging, qualification and testing available on site.

The modules work with high reliability at temperature conditions from -40/-50°C up to +150°C.

Great emphasis is placed on low inductance power bus bar designs, enabling the modules to function under fast switching transients such as, those of next generation Trench Gate IGBT's and SiC MOSFET.

KEY FEATURES

- High DC stability via advanced edge termination design and passivation
- High short circuit capability-wide SCSOA
- Self-limiting short circuit current
- Low switching losses
- $T(vj\ op) = 150^{\circ}\text{C}$
- AlSiC Baseplate for increased thermal cycling capability
- Package design with $CTI > 600$
- Isolated base plate
- 400A to 3600A at 750V to 6500V

APPLICATIONS

- High reliability inverters
- Motor controllers
- Traction drives
- Different circuit topologies (half bridge, single switch, chopper)

1200V IGBT Modules

Part Number	Configuration	Production Status	IC (A)	at TC (°C)	VCE (sat) @ TC=25°C (V)	Total E _{sw} @ TC=125°C (mJ)	R _{th(j-c)} (per switch) (°C/kW)	Baseplate Dims (mm)	Isolation Voltage	Tech
AlSiC Baseplate										
DIM2400ESM12-A	Single	MP	2400	85	2.2	800	6	190 x 140	2.5kV	DNPT
DIM1800ESM12-A	Single	MP	1800	85	2.2	570	8	190 x 140	2.5kV	DNPT
DIM1600FSM12-A	Single	MP	1600	85	2.2	500	9	140 x 130	2.5kV	DNPT
DIM1200FSM12-A	Single	MP	1200	85	2.2	400	12	140 x 130	2.5kV	DNPT
DIM800FSM12-A	Single	MP	800	85	2.2	280	18	140 x 130	2.5kV	DNPT
DIM800DDM12-A	Dual	MP	800	85	2.2	280	18	140 x 130	2.5kV	DNPT
DIM800DCM12-A	Chopper	MP	800	85	2.2	280	18	140 x 130	2.5kV	DNPT
DIM600DDM12-A	Dual	MP	600	85	2.2	200	24	140 x 130	2.5kV	DNPT
DIM400DDM12-A	Dual	MP	400	85	2.2	120	36	140 x 130	2.5kV	DNPT
Copper Baseplate										
DIM1800ESS12-A	Single	MP	1800	85	2.2	570	8	140 x 190	2.5kV	DNPT
DIM1600FSS12-A	Single	MP	1600	85	2.2	500	9	140 x 130	2.5kV	DNPT
DIM1200FSS12-A	Single	MP	1200	85	2.2	400	12	140 x 130	2.5kV	DNPT
DIM800FSS12-A	Single	MP	800	85	2.2	280	18	140 x 130	2.5kV	DNPT
DIM800DCS12-A	Chopper	MP	800	85	2.2	280	18	140 x 130	2.5kV	DNPT
DIM800DDS12-A	Dual	MP	800	85	2.2	280	18	140 x 130	2.5kV	DNPT
DIM600DDS12-A	Dual	MP	600	85	2.2	200	24	140 x 130	2.5kV	DNPT

1700V IGBT Modules

Part Number	Configuration	Production Status	IC (A)	at TC (°C)	VCE (sat) @ TC=25°C (V)	Total E _{sw} @ TC=125°C (mJ)	R _{th(j-c)} (per switch) (°C/kW)	Baseplate Dims (mm)	Isolation Voltage	Tech
DIM2400ESM17-A	Single	MP	2400	75	2.7	1950	6	190 x 140	4 kV	DNPT
DIM1600FSM17-A	Single	MP	1600	75	2.7	1250	9	140 x 130	4 kV	DNPT
DIM1600ECM17-A	Chopper	MP	1600	75	2.7	1250	9	190 x 140	4 kV	DNPT
DIM1200FSM17-A	Single	MP	1200	75	2.7	1000	12	140 x 130	4 kV	DNPT
DIM800FSM17-A	Single	MP	800	75	2.7	700	18	140 x 130	4 kV	DNPT
DIM800DDM17-A	Dual	MP	800	75	2.7	700	18	140 x 130	4 kV	DNPT
DIM800DCM17-A	Chopper	MP	800	75	2.7	785	18	140 x 130	4 kV	DNPT
DIM600DDM17-A	Dual	MP	600	75	2.7	620	24	140 x 130	4 kV	DNPT
DIM600DCM17-A	Chopper	MP	600	75	2.7	620	24	140 x 130	4 kV	DNPT
DIM400DDM17-A	Dual	MP	400	75	2.7	350	36	140 x 130	4 kV	DNPT
DNPT Range										
DIM400DCM17-A	Chopper	MP	400	75	2.7	350	36	140 x 130	4 kV	DNPT
DIM400PHM17-A	Half Bridge	MP	400	75	2.7	350	36	140 x 73	4 kV	DNPT
DIM400PBM17-A	Bi-directional	MP	400	75	4.9	350	36	140 x 73	4 kV	DNPT
TSPT Range										
TIM800DDM17-PSA011	Dual	MP	800	80	2.30	520	18	140 x 130	6 kV	TSPT

* V_{ce(sat)} is measured across both arms of the bi-directional switch.

MP: Mass Production NEW: New Products, Samples NRND: Not Recommended for New Design

TSPT - Trench Soft Punch Through PSPT - Planar Soft Punch Through DNPT - Dynex Non Punch Through DSPT - Dynex Soft Punch Through

3300V IGBT Modules

Part Number	Configuration	Production Status	IC (A)	at TC (°C)	VCE (sat) @ TC=25°C (V)	Total E _{sw} @ TC=125°C (mJ)	R _{th(j-c)} (per switch) (°C/kW)	Baseplate Dims (mm)	Isolation Voltage	Tech
Standard Range										
DIM1500ESM33-MS	Single	MP	1500	120	2.2	8200	7	190 x 140	6kV	DSPT
DIM1500ESM33-TS	Single	MP	1500	110	2.2	6200	8	190 x 140	6kV	DSPT
DIM1500ASM33-TS001	Single	MP	1500	110	2.2	6200	8	190 x 140	10.2kV	DSPT
DIM1000NSM33-TS	Single	MP	1000	110	2.2	3850	12	140 x 130	6kV	DSPT
DIM1000XSM33-TS001	Single	MP	1000	110	2.2	3850	12	140 x 130	10.2kV	DSPT
DIM1000ECM33-TS	Chopper	MP	1000	110	2.2	4150	12	190 x 140	6kV	DSPT
DIM1000ACM33-TS001	Chopper	MP	1000	110	2.2	4150	12	190 x 140	10.2kV	DSPT
DIM500GDM33-TS	Dual	MP	500	110	2.2	2100	24	140 x 130	6kV	DSPT
DIM500GCM33-TS	Chopper	MP	500	110	2.2	2100	24	140 x 130	6kV	DSPT
DIM250PKM33-TS	Chopper	MP	250	110	2.2	1040	48	140 x 73	6kV	DSPT
DIM250PLM33-TS	Chopper	MP	250	110	2.2	1040	48	140 x 73	6kV	DSPT
DIM250PHM33-TS	Half Bridge	MP	250	110	2.2	1040	48	140 x 73	6kV	DSPT
DIM125PHM33-TS	Half Bridge	MP	125	110	2.2	520	96	140 x 73	6kV	DSPT
Low Conduction Loss Range										
DIM1500ESM33-TL	Single	MP	1500	115	2.0	7800	8	190 x 140	6 kV	DSPT
DIM1500ASM33-TL001	Single	MP	1500	115	2.0	7800	8	190 x 140	10.2 kV	DSPT
DIM1000NSM33-TL	Single	MP	1000	115	2.0	5200	12	140 x 130	6 kV	DSPT
DIM1000XSM33-TL001	Single	MP	1000	115	2.0	5200	12	140 x 130	10.2 kV	DSPT
DIM1000ECM33-TL	Chopper	MP	1000	115	2.0	5200	12	190 x 140	6 kV	DSPT
DIM1000ACM33-TL001	Chopper	MP	1000	115	2.0	5200	12	190 x 140	10.2 kV	DSPT
DIM500GDM33-TL	Dual	MP	500	115	2.0	2650	24	190 x 140	6 kV	DSPT
DIM500GCM33-TL	Chopper	MP	500	115	2.0	2650	24	140 x 130	6 kV	DSPT
DIM250PHM33-TL	Half Bridge	MP	250	115	2.0	1300	48	140 x 73	6 kV	DSPT
DIM250PKM33-TL	Chopper	MP	250	115	2.0	1300	48	140 x 73	6kV	DSPT
DIM250PLM33-TL	Chopper	MP	250	115	2.0	1300	48	140 x 73	6 kV	DSPT
DIM125PHM33-TL	Half Bridge	MP	125	115	2.0	650	96	140 x 73	6kV	DSPT
Low Switching Loss Range										
DIM1800ESM33-VF	Single	NEW	1800	110	2.3	8200	8	190 x 140	6kV	TSPT
DIM1500ESM33-MF	Single	MP	1500	108	3.3	4760	7	190 x 140	6kV	DSPT
DIM1200ASM33-F	Single	MP	1200	90	2.8	4400	48	140 x 73	6kV	DSPT
DIM1200ESM33-F	Single	MP	1200	90	2.8	4400	8	190 x 140	6kV	DSPT
DIM800NSM33-F	Single	MP	800	90	2.8	2950	12	140 x 130	6kV	DSPT
DIM800XSM33-F	Single	MP	800	90	2.8	2950	12	140 x 130	10.2kV	DSPT
DIM800ECM33-F	Chopper	MP	800	90	2.8	2950	12	190 x 140	6kV	DSPT
DIM400NSM33-F	Single	MP	400	90	2.8	1470	24	140 x 130	6kV	DSPT
DIM400XCM33-F	Chopper	MP	400	90	2.8	1470	24	140 x 130	10.2kV	DSPT
DIM200PLM33-F	Chopper	MP	200	90	2.8	655	48	140 x 73	6kV	DSPT
DIM200PKM33-F	Chopper	MP	200	90	2.8	655	48	140 x 73	6kV	DSPT
DIM200PHM33-F	Half Bridge	MP	200	90	2.8	655	48	140 x 73	6kV	DSPT
DIM100PHM33-F	Half Bridge	MP	100	90	2.8	335	96	140 x 73	6kV	DSPT

4500V IGBT Modules

Part Number	Configuration	Production Status	IC (A)	at Tc (°C)	VCE (sat) @ Tc=25°C (V)	Total Esw @ Tc=125°C (mJ)	Rth(j-c) (per switch) (°C/kW)	Baseplate Dims (mm)	Isolation Voltage	Tech
Standard Range										
DIM1200ASM45-TS	Single	MP	1200	90	2.7	11100	8	190 x 140	7.4 kV	DSPT
DIM1200ASM45-TS001	Single	MP	1200	90	2.7	11100	8	190 x 140	10.2 kV	DSPT
DIM800ACM45-TS	Chopper	MP	800	90	2.7	7400	12	190 x 140	7.4kV	DSPT
DIM800ACM45-TS001	Chopper	MP	800	90	2.7	7400	12	190 x 140	10.2kV	DSPT
DIM800XSM45-TS	Single	MP	800	90	2.7	7400	12	140 x 130	7.4 kV	DSPT
DIM800XSM45-TS001	Single	MP	800	90	2.7	7400	12	140 x 130	10.2 kV	DSPT
DIM400XCM45-TS	Chopper	MP	400	90	2.7	3800	24	140 x 130	7.4 kV	DSPT
DIM400XCM45-TS001	Chopper	MP	400	90	2.7	3800	24	140 x 130	10.2 kV	DSPT
DIM400XSM45-TS	Single	MP	400	90	2.7	3800	24	140 x 130	7.4 kV	DSPT
DIM400XSM45-TS001	Single	MP	400	90	2.7	3800	24	140 x 130	10.2 kV	DSPT
Low Conduction Loss Range										
DIM1200ASM45-TL	Single	MP	1200	90	2.3	11650	8	190 x 140	7.4 kV	DSPT
DIM1200ASM45-TL001	Single	MP	1200	90	2.3	11650	8	190 x 140	10.2 kV	DSPT
DIM800XSM45-TL	Single	MP	800	90	2.3	9100	12	140 x 130	7.4 kV	DSPT
Low Switching Loss Range										
DIM1500ASM45-UF	Single	NEW	1500	90	3.2	10600	8	190 x 140	7.4 kV	TSPT
DIM1200ASM45-TF	Single	MP	1200	90	3.5	8950	8	190 x 140	7.4 kV	DSPT
DIM1200ASM45-TF001	Single	MP	1200	90	3.5	8950	8	190 x 140	10.2 kV	DSPT

6500V IGBT Modules

Part Number	Configuration	Production Status	IC (A)	at Tc (°C)	VCE (sat) @ Tc=25°C (V)	Total Esw @ Tc=125°C (mJ)	Rth(j-c) (per switch) (°C/kW)	Baseplate Dims (mm)	Isolation Voltage	Tech
Standard Range										
DIM1000ASM65-US	Single	NEW	1000	115	2.6	14000	9	190 x 140	10.2kV	TSPT
DIM750ASM65-TS	Single	MP	750	100	2.8	11600	9	190 x 140	10.2 kV	DSPT
DIM500XSM65-TS	Single	MP	500	90	3.0	7700	13.5	140 x 130	10.2 kV	DSPT
DIM500ACM65-TS	Chopper	MP	500	90	3.0	6700	15	190 x 140	10.2 kV	DSPT
DIM250XCM65-TS	Chopper	MP	250	90	3.0	3350	30	140 x 130	10.2 kV	DSPT
Low Conduction Loss Range										
DIM1000ASM65 - UL	Single	NEW	1000	90	2.6	10300	9	190 x 140	10.2 kV	TSPT
DIM750ASM65-TL	Single	MP	750	100	2.5	16200	9	190 x 140	10.2 kV	DSPT
Low Switching Loss Range										
DIM1000ASM65-UF	Single	NEW	1000	90	3.2	15000	9	190 x 140	10.2 kV	TSPT
DIM750ASM65-TF	Single	NEW	750	97	3.2	10200	9	190 x 140	10.2 kV	DSPT

* Vce(sat) is measured across both arms of the bi-directional switch.

MP: Mass Production NEW: New Products, Samples NRND: Not Recommended for New Design

TSPT - Trench Soft Punch Through PSPT - Planar Soft Punch Through DNPT - Dynex Non Punch Through DSPT - Dynex Soft Punch Through

SHV & SLV Modules

High Engineering Capability for Customised Design

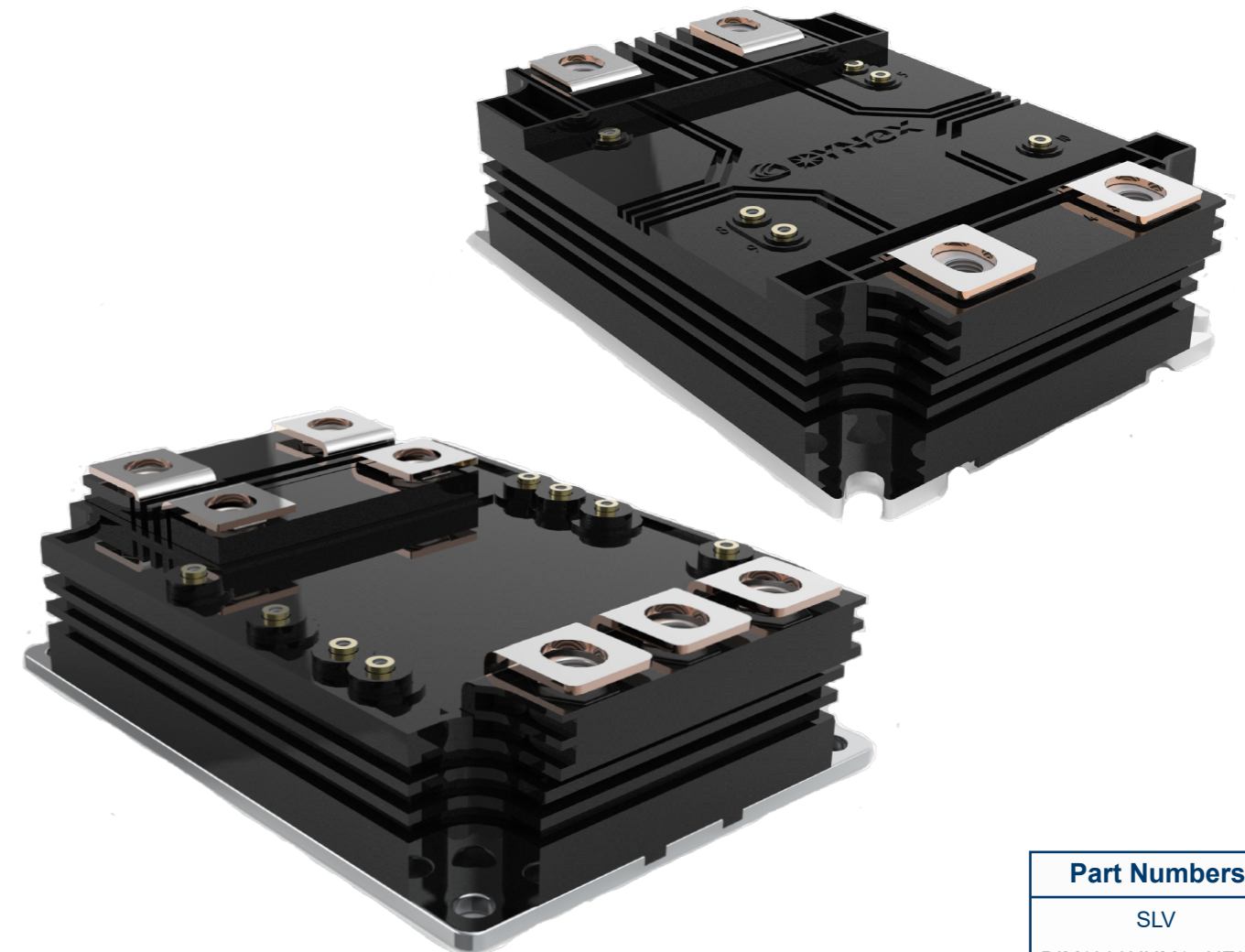

Part Numbers

SLV

DIM1000UHM17-UF000

DIM500UHM33-UF000

SHV

DIM450VHM33-UF000

DIM375VHM45-UF000

DIM250VHM65-UF000

Standard High Voltage (SHV) packages 3.3kV to 6.5kV with 24nH level inductance
Standard Low Voltage (SLV) packages up to 3.3kV with 10nH level inductance
Low switching and conduction power loss with exceptional controllability

Part Number	Configuration	Production Status	IC (A)	at Tc (°C)	VCE (sat) @ Tc=25°C (V)	Total Esw @ Tc=125°C (mJ)	Rth(j-c) (per switch) (°C/kW)	Baseplate Dims (mm)	Isolation Voltage	Tech
SHV										
DIM450VHM33-UF000	Half Bridge	NEW	450	110	2.6	1810	28	140 x 100	10.2 kV	TSPT

4500V IGBT Press-pack

Part Number	Configuration	Production Status	IC (A)	at TC (°C)	VCE (sat) @ TC=25°C (V)	Total Esw @ TC=125°C (mJ)	Rth(j-c) (per switch) (°C/kW)	Flange OD/Contact OD/Height (mm)	Tech
All-IGBT									
DPI2100P45A5200	All IGBT	NEW	2100	95	2.4	19800	4.4	170/125/26.5	DSPT
All-FRD									
DPF2100P45A0052	FRD	NEW	2100	105	-	8800	4.4	170/125/26.5	DSPT
Co-Pack									
DPI1600P45C3616	Co-Pack	NEW	1600	90	2.5	17100	6.4	170/125/26.5	DSPT
DPI1200P45C2626	Co-Pack	NEW	1200	90	2.6	17600	8.8	170/125/26.5	DSPT

TSPT - Trench Soft Punch Through PSPT - Planar Soft Punch Through DNPT - Dynex Non Punch Through DSPT - Dynex Soft Punch Through

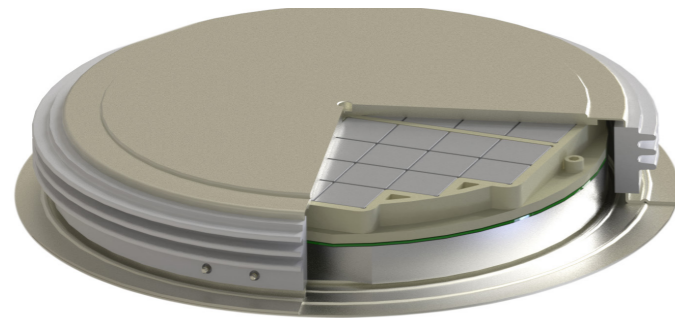

Product Range

Dynex are able to supply press-pack IGBTs with a range of industry -standard contact diameters from 34mm to 150mm and current ratings from 120A up to 3000A at 4500V. An integrated research and development and manufacturing facility enables chips and devices to be tailored to customers' applications. Their ease of use, high reliability and robustness has made Dynex press-packs the product of choice for a variety of applications, including HVDC and medium voltage drives. Interested parties should contact the factory with their requirements.

Product Features

- Dynamic load-balancing (DLB) technology maximises safe operating area, gives high reliability and improves ease of use compared to conventional press-pack IGBT designs
- Silver-sinter bonding applied to basic units between the chip and adjacent molybdenum platelets ensures outstanding reliability and improved thermal performance
- Silicone edge passivation applied to Dynex press-pack chips and a hermetically sealed housing give robust high voltage blocking performance
- A dedicated auxiliary emitter connection ensures synchronisation of gate drive signals between chips, mitigating the effects of power circuit di/dt on the driver circuit.

Advantages of press-pack IGBTs

Press-pack IGBTs are an alternative to isolated-base wire-bonded plastic modules, relying instead on pressure contacts. The ease with which press-packs can be stacked makes them the device of choice for applications that require series operation. Their ratings typically extend to higher currents than modules and, by using pressure contacts instead of wire bonds and solder joints, they typically benefit from higher reliability. In contrast to wire bonds, which typically fuse and render modules open-circuit in the event of failure, the use of pressure contacts ensures press-packs fail to short circuit. In the event of a high energy failure, their robust housings offer greater rupture resistance than modules.

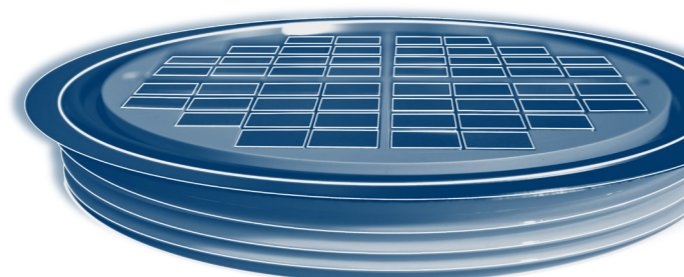

Custom IGBT Modules

Enhancing our range of power semiconductor devices, Dynex has the capability to design, develop and manufacture custom IGBT modules.

Applications for power electronic devices often involve harsh operating conditions or environments, necessitating devices capable of meeting these requirements.

Dynex utilise our vast experience in the manufacture of power semiconductors, to design and produce high reliability IGBT modules, customised to meet the individual demands for end applications including those in the aerospace, automotive, medical, renewable energy and traction markets.

Dynex capabilities can encompass the following:

- Laser welded assemblies
- Ultrasonic welding processes
- Copper wire bonds
- Various die technologies (Trench gate, SiC)
- Liquid cooled heatsinks
- Customised busbar arrangements
- Silver sintering
- Customised packaging (case materials)
- Hermetic sealed packages

Using our experience in the design of IGBT modules, Dynex has designed and manufactured modules that have helped our customers:

- Reduce system cost
- Reduce total system size and weight
- Improve thermal characteristics
- Maximise system efficiency
- Operate in severe environments

Using our in-house design team, Dynex continue to develop processes and designs to utilise the latest techniques to improve cooling, current output, lifetime and reliability.

Through initial concept to full production, Dynex will support your requirements to provide enhanced, reliable device outlines to meet your specific demands.

For more information on how Dynex can help with your custom IGBT needs, please email powersolutions@dynexsemi.com

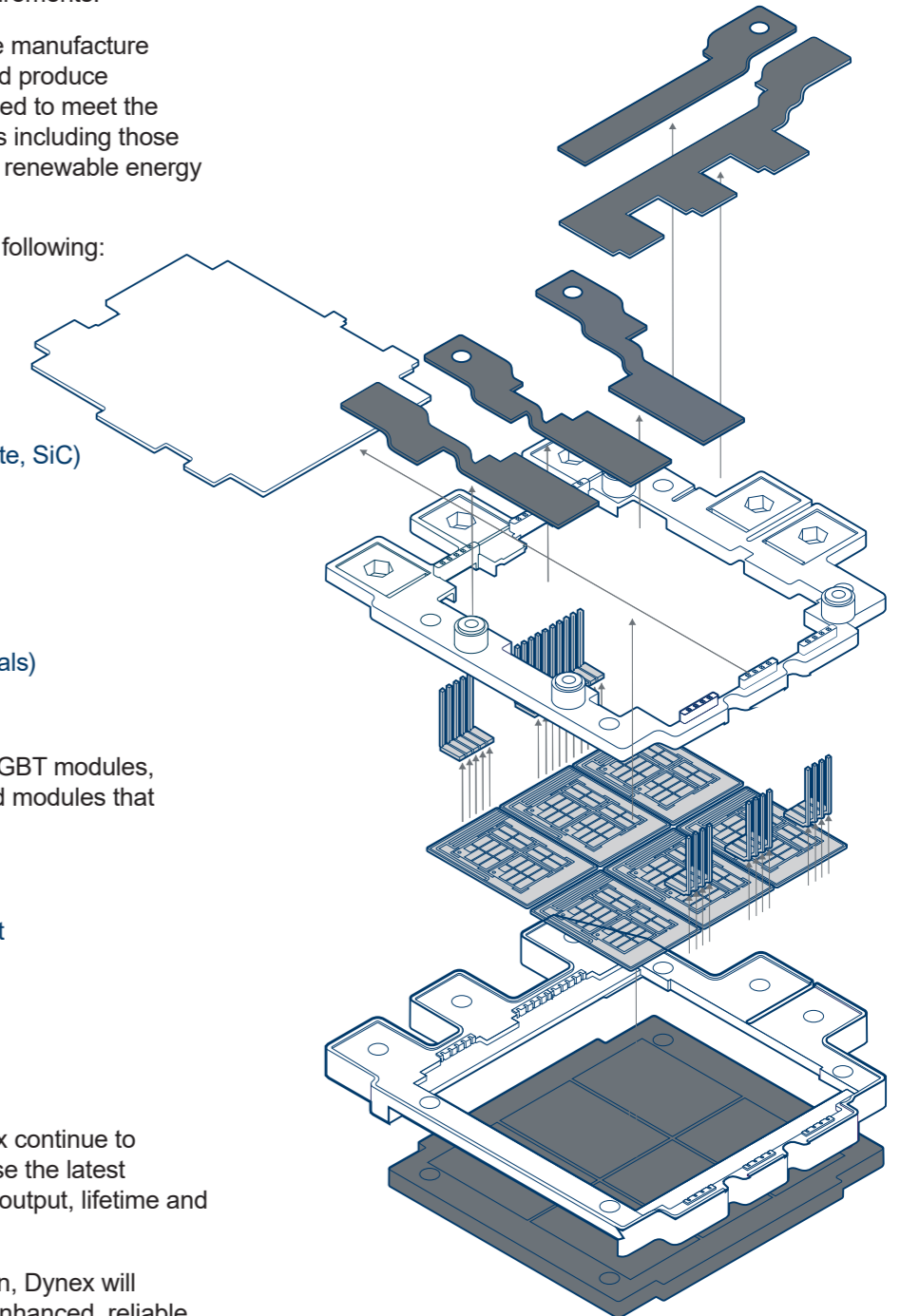

DESIGN TOOL

Easy selection of the Dynex device most applicable to your application

Our Design Tool contains a topology simulator, that provides an analysis of the behavior of our components in your specific application. All typical power electronic typologies are available with system losses, current ripple, and a maximum thermal resistance as a starting point for your thermal design. The Design Tool offers the comparison of different component configurations in each topology within a few clicks.

Choose Converter Topology: ?

- 2-Level Single Phase
- AC-Converters ---
- 2-Level Single Phase
- 2-Level Three Phase
- 3-Level Three Phase (T-Type)
- 3-Level Three Phase (I-Type)
- 5-Level Three Phase (I-Type)
- Rectifiers ---
- Diode Rectifier, Single Phase
- Diode Rectifier, Three Phase
- DC-Topologies ---
- Buck Converter
- Boost Converter

Parameters for System Simulation:

Grid voltage (V) <input type="text" value="400.0"/>	Grid current (A) <input type="text" value="57.74"/>	Grid frequency (Hz) <input type="text" value="50"/>
DC-Link voltage (V) <input type="text" value="700.0"/>	Grid inductance (H) <input type="text" value="0.004"/>	Average ambient temperature (°C) <input type="text" value="25"/>
Switching frequency (Hz) <input type="text" value="2000"/>	Power factor <input type="text" value="0.9"/>	Average junction temperature (°C) <input type="text" value="100"/>
Third harmonic injection <input type="checkbox" value="Off"/>	Reactive power <input type="checkbox" value="Inductive"/>	

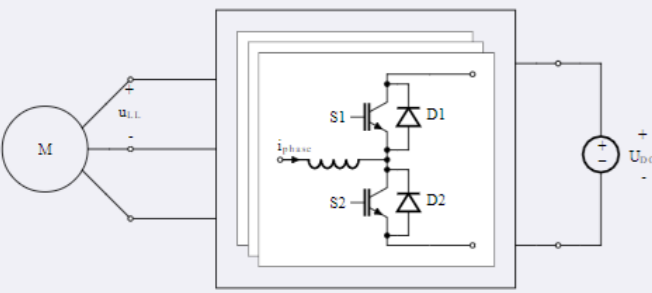

2 Level Three Phase Converter

Overview system losses



Loss Type	Design A	Design B	Design C
Conduction Losses	~100	~100	~100
Switching Losses	~350	~450	~350
Combined Losses	~450	~550	~450

Alternating current and grid voltage

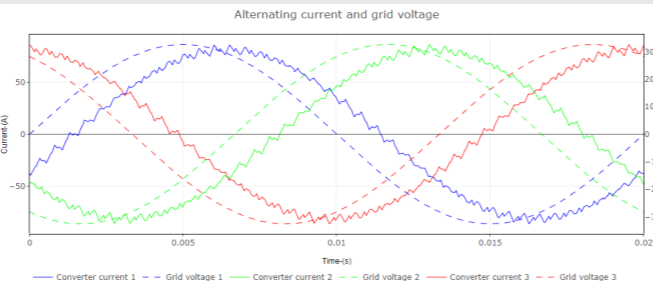

Our Design Tool is designed to assist you in selecting the right Dynex products, using an integrated interactive datasheet, which allows you to analyse our component's properties and performance at a specific operation point considering current, voltage and junction temperature.

Operating point 1 (OP 1)	Operating point 2 (OP 2)
Junction temperature in °C <input type="text" value="25"/>	Junction temperature in °C <input type="text" value="125.0"/>
Voltage to be blocked in V <input type="text" value="600.0"/>	Voltage to be blocked in V <input type="text" value="600.0"/>

The instantaneous and average power losses in each semiconductor component of the circuit are displayed for each topology, selected alongside other outputs shown below.

- Converter output (pulsed and fundamental) & grid voltage
- Alternating current & grid voltage
- Current separated into actual conducting devices
- Conduction losses
- Switching energies

Access the tool via www.dynexsemi.com or directly through <https://dynex.pe-finder.de/>



FRD Modules

Regulate electricity flow to ensure higher reliability and increased efficiency

Dynex FRD modules regulate electricity flow to ensure high reliability and increased efficiency in motor drives and other variable speed processes.

The family of high-voltage Fast Recovery Diode modules have been designed for use in rail traction, industrial motor drives, induction heating and power generation.

The FRD modules are designed to match and work as the input rectifiers for the existing Dynex range of IGBT modules.

Fast switching times and low reverse recovery losses allow high frequency operation, making the device suitable for the latest drive designs, employing PWM and high frequency switching.

KEY FEATURES

- Low reverse recovery charge
- High switching speed
- Low forward volt drop
- Isolated AISiC base with AlN substrates
- Single, double and triple diode configurations available with current ratings up to 3600A

APPLICATIONS

- Chopper diodes
- Boost and buck circuits
- Free-wheel circuits
- Multi-level switch inverters
- Rail traction
- Industrial motor drives
- Induction heating
- Power generation

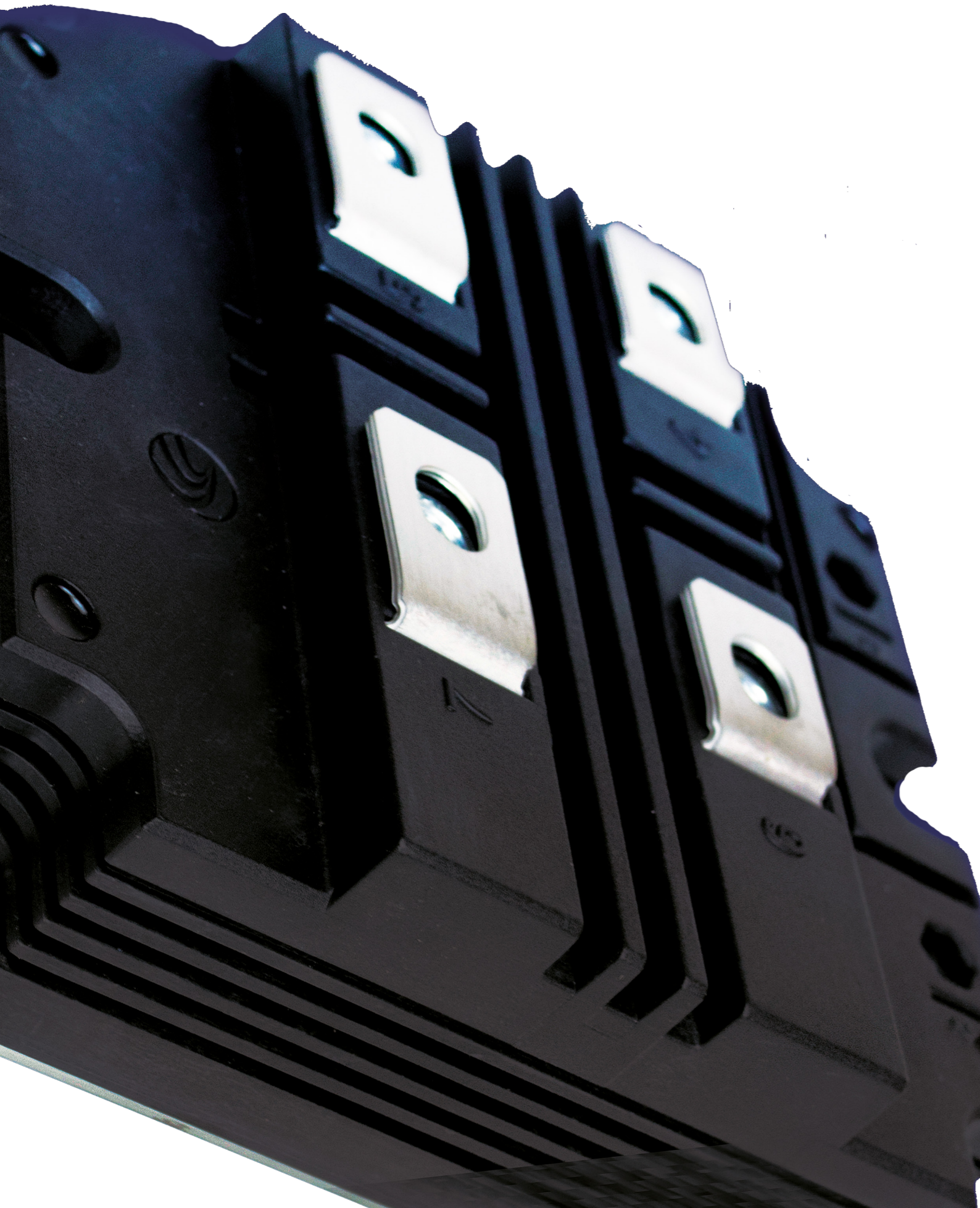

1200V FRD Modules

Part Number	Configuration	Production Status	IF (A per arm)	at TC (°C)	Baseplate Dims (mm)	Isolation Voltage	IF (A as single diode with external connection)	Vf@ Tvj =25 °C	I ² t (kA ² s)	Qrr@ Tvj	Erec@ Tvj	Rth(j-c) (per arm) (°C/kW)
AISIC Baseplate												
DFM1200EXM12-A	Triple Diode	MP	1200	75	190 x 140	2.5 kV	3600	1.9	200	300	140	20
DFM1200FXM12-A	Dual Diode	MP	1200	75	140 x 130	2.5 kV	2400	1.9	200	300	140	20
DFM900FXM12-A	Dual Diode	MP	900	75	140 x 130	2.5 kV	1800	1.9	150	225	105	27
DFM600FXM12-A	Dual Diode	MP	600	75	140 x 130	2.5 kV	1200	1.9	100	150	70	40
Copper Baseplate												
DFM1200FXS12-A	Dual Diode	NRND	1200	75	140 x 130	2.5 kV	2400	1.9	200	300	140	20
DFM900FXS12-A	Dual Diode	NRND	900	75	140 x 130	2.5 kV	1800	1.9	150	225	105	27
DFM600FXS12-A	Dual Diode	NRND	600	75	140 x 130	2.5 kV	1200	1.9	150	150	70	40

1800V FRD Modules

Part Number	Configuration	Production Status	IF (A per arm)	at TC (°C)	Baseplate Dims (mm)	Isolation Voltage	IF (A as single diode with external connection)	Vf@ Tvj =25 °C	I ² t (kA ² s)	Qrr@ Tvj	Erec@ Tvj	Rth(j-c) (per arm) (°C/kW)
AISIC Baseplate												
DFM1200EXM18-A	Triple Diode	MP	1200	75	190 x 140	4 kV	3600	2.0	480	540	360	20
DFM1200FXM18-A	Dual Diode	MP	1200	75	140 x 130	4 kV	2400	2.0	480	540	360	20
DFM900FXM18-A	Dual Diode	MP	900	75	140 x 130	4 kV	1800	2.0	270	410	270	27
DFM600FXM18-A	Dual Diode	MP	600	75	140 x 130	4 kV	1200	2.0	120	160	120	40

3300V FRD Modules

Part Number	Configuration	Production Status	IF (A per arm)	at TC (°C)	Baseplate Dims (mm)	Isolation Voltage	IF (A as single diode with external connection)	Vf@ Tvj =25 °C	I ² t (kA ² s)	Qrr@ Tvj	Erec@ Tvj	Rth(j-c) (per arm) (°C/kW)
TS Range												
DFM1000EXM33-TS	Triple Diode	MP	1000	90	190 x 140	6 kV	3000	2.4	320	1070	1300	24
DFM1000NXM33-TS	Dual Diode	MP	1000	90	140 x 130	6 kV	2000	2.4	320	1070	1300	24
DFM500NXM33-TS	Dual Diode	MP	500	90	140 x 130	6 kV	1000	2.4	80	540	650	48
DFM250PXM33-TS	Series Pair	MP	250	90	140 x 73	6 kV	N/A	2.4	20	270	330	96
F Range (fast)												
DFM1200NXM33-F	Dual Diode	MP	1200	70	140 x 130	6 kV	2400	2.9	720	900	900	16
DFM800NXM33-F	Dual Diode	MP	800	70	140 x 130	6 kV	1600	2.9	320	600	600	24
DFM400NXM33-F	Dual Diode	MP	400	70	140 x 130	6 kV	800	2.9	80	300	300	48
DFM400PXM33-F	Series Diode	MP	400	70	140 x 73	6 kV	N/A	2.9	80	300	300	48
DFM200PXM33-F	Series Diode	MP	200	70	140 x 73	6 kV	N/A	2.9	20	125	130	96
DFM100PXM33-F	Series Diode	MP	100	70	140 x 73	6 kV	N/A	2.9	5	65	65	192

Notes:
 * Refer to datasheets for Tvj max values www.dynexsemi.com/products/semiconductors/frd-modules
 * V_{ce(sat)} is measured across both arms of the bi-directional switch.
 MP: Mass Production NEW: New Products, Samples NRND: Not Recommended for New Design

4500V FRD Modules

Part Number	Configuration	Production Status	IF (A per arm)	at TC (°C)	Baseplate Dims (mm)	Isolation Voltage	IF (A as single diode with external connection)	Vf@ Tvj =25 °C	I ² t (kA ² s)	Qrr@ Tvj	Erec@ Tvj	Rth(j-c) (per arm) (°C/kW)
TS Range												
DFM1200AXM45-TS	Triple Diode	MP	1200	65	190 x 140	7.4kV	3600	2.8	460	2200	4000	16
DFM1200AXM45-TS001	Triple Diode	MP	1200	65	190 x 140	10.2 kV	3600	2.8	460	2200	4000	16
DFM1200XXM45-TS	Dual Diode	MP	1200	65	140 x 130	7.4kV	2400	2.8	460	2200	4000	16
DFM1200XXM45-TS001	Dual Diode	MP	1200	65	140 x 130	10.2 kV	2400	2.8	460	2200	4000	16
DFM800XXM45-TS	Dual Diode	MP	800	65	140 x 130	7.4 kV	1600	2.8	300	1450	2700	24
DFM800XXM45-TS001	Dual Diode	MP	800	65	140 x 130	10.2 kV	1600	2.8	300	1450	2700	24
DFM400XXM45-TS	Dual Diode	MP	400	65	140 x 130	7.4kV	800	2.8	150	750	1350	48

6500V FRD Modules

Part Number	Configuration	Production Status	IF (A per arm)	at TC (°C)	Baseplate Dims (mm)	Isolation Voltage	IF (A as single diode with external connection)	Vf@ Tvj =25 °C	I ² t (kA ² s)	Qrr@ Tvj	Erec@ Tvj	Rth(j-c) (per arm) (°C/kW)
TS Range												
DFM750AXM65-TS	Triple Diode	MP	750	70	190 x 140	10.2 kV	2250	3.8	218	1500	3000	20
DFM500XXM65-TS	Dual Diode	MP	500	70	140 x 130	10.2 kV	1000	3.8	97	1000	2000	30
DFM250XXM65-TS	Dual Diode	MP	250	70	140 x 130	10.2 kV	500	3.8	24	500	1000	60

* V_{ce(sat)} is measured across both arms of the bi-directional switch.
 MP: Mass Production NEW: New Products, Samples NRND: Not Recommended for New Design



Bipolar Thyristors

Reliable and efficient transfer of energy for a range of applications

Dynex Bipolar range are produced in both Lincoln, England and Zhuzhou, China. Development continues to produce designs tailored for particular applications with lower losses, higher blocking voltages and higher current capability.

The range consists of Phase Control, Gate Turn Off, Pulse Power, Asymmetric Thyristors, Rectifier fast Recovery and Flat Base Rectifier Diodes.

KEY FEATURES

- Thinner silicon, lower conduction losses
- Unique bevel maximises current and surge ratings
- Advanced implanted aluminium diffusion techniques
- Current ratings from 370A to 7610A
- Voltage ratings from 1400V to 8500V with custom designs
- Full blocking voltage capability at line frequencies from -40°C to 125°C

APPLICATIONS

- High power drives
- High voltage power supplies
- Static switches
- Industrial AC and DC drives
- Wind energy systems
- Soft starters, STATS

Part Number	VDRM (V)	VRRM (V)	IT (AV) at TC= 80°C (A)	ITCM (A)	dV/dt (V/μs)	di/dt (A/μs)	Rth(j-c) (°C/W)	Outline Type Code	Flange OD Contact OD Height (mm)	Snubber Diode	Anti-parallel and Freewheel Diode	Clamping Force (kN) min - max
Asymmetric Types												
Up to 1300V												
DGT304SE	1300	16	250	700	500	500	0.075	E	41.9/25/15	-	DF451	5-6
Up to 1800V												
DGT305SE	1800	16	240	700	500	500	0.075	E	41.9/25/15	-	DF451	5-6
Up to 2500V												
DG306AE	2500	16	225	600	1000	300	0.075	E	41.9/25/15	-	DFS454	5-6
DG406BP	2500	16	500	1200	1000	300	0.041	P	56/38/27	DSF8025SE	DSF8025SE	11-15
DG646BH	2500	16	867	2500	1000	300	0.018	H	100/63/26.5	DSF8025SE	DF051	18-22
Up to 4500V												
DG408BP	4500	16	320	1000	1000	300	0.041	P	56/38/27	DSF8045SK	DSF8045SK	11-15
DG648BH	4500	16	745	2000	1000	300	0.018	H	100/63/26.5	DSF8045SK	DSF20545SF	18-22
DG758BX	4500	16	870	3000	1000	300	0.0146	X	112/66/27	DSF8045SK	DSF21545SV	33-37
DG808BC	4500	16	780	3000	1000	400	0.014	C	108/77.2/27	DSF8045SK	DSF21545SV	28-44
DG858BW	4500	16	1180	4000	1000	300	0.011	W	120/84.6/27.7	DSF8045SK	DSF21545SV	36-44
DG858DW	4500	16	1100	3000	750	300	0.011	W	120/84.6/27.7	DSF8045SK	DSF21545SV	36-44
Reverse Blocking												
Up to 1300V												
DGT304RE	1300	1300	250	700	500	500	0.075	E	41.9/25/15	-	DF451	5-6
Up to 1800V												
DGT305RE	1800	1800	240	700	500	500	0.075	E	41.9/25/15	-	DF451	5-6
DG858BW	4500	16	1180	4000	1000	300	0.011	W	120/84.6/27.7	DSF8045SK	DSF21545SV	36-44

Part Number	VDRM (V)	VRRM (V)	IT (AV) at TC= 80°C (A)	ITSM at Tvj VR = 0 (kA)	dV/dt (V/μs)	di/dt (A/μs)	to lpk (kA)	Rth(j-c) (°C/W)	Outline Type Code	Flange OD Contact OD Height (mm)	Clamping Force (kN) min - max
Pulsed Power Thyristors (SCR)											
ACR300SG33	3300	20	493	6.5	3000	2000	0.125	0.042	G	58.5/34/27	6-8
PT40QPX45	4500	16	760	13	200	5000	20	0.033	P	56/38/37	11-15
PT60QHX45	4500	16	1000	22.5	175	10000	40	0.013	H	100/63/26.5	18-22
PT85QWX45	4500	16	1670	37	200	22000	90	0.01	W	120/84.6/27.7	36-44

Note: 1. Please contact customer services for the availability of clamps for these devices.

The PT family of Pulsed Power Thyristors (PPTs) are based on Dynex's GTO technology, designed for long term stability under DC voltages. The structures are resistant to cosmic ray induced failures at normal working voltages.

The Pulsed Power Thyristor range may be used to connect a source of stored energy such as a capacitor to a load, or to bypass and protect the load in the case of a crowbar circuit. In pulsed power applications where the rate of current is very fast, the pulsed power switch acts as a closing switch and standard phase control thyristors (SCRs) are likely to fail due to the high di/dt experienced.

Pulsed Power Thyristors may also be required to act in the opening switch mode. Such applications may include; those where voltage is reapplied to the pulsed power switch shortly after closing, and the switch needs to have recovered blocking capability, or the transferred energy needs to be controlled. In these applications, the switch needs to have turn-off capability to reduce the natural turn-off time (tq) of the device. The device is operated in GTO mode with the appropriate commutating gate drive. Dynex has been supplying thyristors used as crowbars to protect other high power circuitry in railway propulsion units for many years.

In the field of ignitron replacements and weld switches, Dynex has been a leader in the application of solid state devices. Dynex has been involved in the design and manufacture of assemblies for the pulsed power academic communities on the West Coast of America and at CERN, Switzerland.

For more information on how Dynex can help with your pulsed power needs, please e-mail us at powersolutions@dynexsemi.com

Thyristor Components

Take a look at the components that make up our encapsulated device. The devices are fully floating and therefore are not bonded together and are clamped together to achieve electrical and thermal contact instead. This allows our products to have an excellent temperature cycling life expectancy.

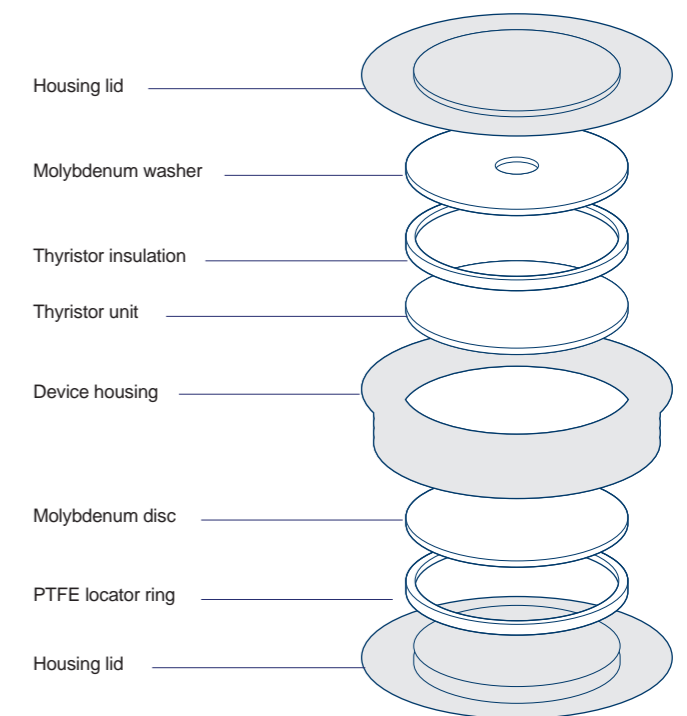

Asymmetric Bypass Thyristors

Part Number	VDRM (V)	VRRM (V)	IT (AV) at TC= 80°C (A)	ITCM (A)	dV/dt (V/μs)	Non Rep. di/dt (A/μs)	Rth(j-c) (°C/W)	Outline Type Code	Flange OD Contact OD Height (mm)	DC Cosmic Ray Failure Rate @ 50% VRRM (FITs)	Clamping Force (kN) min - max
ACR3200VR33	1000	3300	3200	43	10	1500	0.00746	V	110/73/27.57	9	48-59
ACR2900VR45	1000	4500	2900	39	10	1300	0.00746	V	110/73/27.69	8	48-59

The Bypass Thyristor range are specifically designed for protection of IGBT modules in VSC multi-level applications, where a reduced forward blocking voltage is required. In these applications, a thyristor must rapidly divert fault currents from an IGBT diode to protect it from damage. Dynex have designed devices with improved current and surge ratings to assist fault diversion.

Such protective thyristors are required to block in parallel with the IGBT diode, and as such experience waveforms that are non typical of thyristor applications. They are resistant to fast voltage transients, which can be exposed to due to the switching of the IGBT diode. The device structures also have greatly enhanced hardness to cosmic ray induced failures, which become significant at high DC voltage duty cycles.



Part Number	VRRM (V)	IF (AV) at TC = 100° (A)	IFSM at Tvj VR=0 (kA)	I ² t at Tvj VR = 0 (MA ² s)	Rth(j-c) (°C/W)	IFM (A)	VFM@ IFM & TC= 25°C (V)	Outline Type Code	Flange OD Contact OD Height (mm)	Clamping Force (kN) min - max
Up to 1400V										
DRD520T14	1400	520	5.9	0.17	0.08	800	1.45	T	42/19/13.5	4-6
DRD710T14	1400	866	8.0	0.3	0.07	600	1.20	T	42/19/15	3.5-5
DRD1360D14	1400	1360	15.2	1.16	0.035	1500	1.3	D	47/29/14.5	8-12
DRD1510G14	1400	1510	16.8	1.41	0.035	1500	1.2	G	58/34/26.5	12-18
DRD2770F14	1400	2770	31	4.81	0.02	1500	1.05	F	75/47/26.5	18-26
DRD3220X14	1400	3220	35.8	6.41	0.018	3000	1.15	X	85/53/26.5	26-34
DRD4650C14	1400	4650	45	10.13	0.0125	3000	1.05	C	100/63/26.5	40-50
DRD6080V14	1400	6080	60	18.00	0.01	3000	1.05	V	110/73/26.5	50-62
Up to 2800V										
DRD4890L15	1500	5794	57.0	16.2	0.013	3000	1.05	L	102/63/32.9	40-48
DRD2460F18	1800	2996	41.3	8.5	0.022	3400	1.18	F	76/48/26.5	18-22
DRD5460Y20	2000	6654	100.0	50.0	0.0095	3000	1.00	Y	112.5/73/36.7	38-47
DRD410T22	2200	410	4.9	0.12	0.08	800	1.85	T	42/19/13.5	4-6
DRD990D22	2200	990	12.5	0.78	0.035	1500	1.60	D	47/29/14.5	8-12
DRD1100G22	2200	1100	13.9	0.966	0.035	1500	1.45	G	58/34/26.5	12-18
DRD2030F22	2200	2030	25.7	3.30	0.02	1500	1.20	F	75/47/26.5	18-26
DRD2360X22	2200	2360	29.8	4.44	0.018	3000	1.35	X	85/53/26.5	26-34
DRD3430C22	2200	3430	42.2	8.9	0.0125	3000	1.20	C	100/63/26.5	40-50
DRD4460V22	2200	4460	56.4	15.90	0.01	3000	1.15	V	110/73/26.5	50-62
DRD6380W22	2200	6380	78	30.42	0.007	6000	1.09	W	120/84/26.5	62-78
DRD6800A22	2200	6800	94	44.18	0.0057	6000	1.03	A	150/100/35	80-100
DRD8880H22	2200	8880	125	78.13	0.004	6000	0.98	H	172/110/35	110-130
DRD2880L25	2500	3438	32.0	5.12	0.013	1500	1.05	L	102/63/34.1	40-48
DRD4780Y26	2600	5788	81.0	33.0	0.0095	3000	1.05	Y	112/73/37.7	38-47
DRD1960F28	2800	2372	31.3	4.9	0.022	3400	1.30	F	76/48/27	18-22
DRD6990M28	2800	8790	95.0	45.1	0.00558	3000	0.97	M	148/100/26	75-91
DRD1320G30	2800	1849	20.0	2.0	0.032	1800	1.30	G	58.5/34/27	11.5-13.5
Up to 3400V										
DRD850D34	3400	850	10.8	0.583	0.035	1500	1.95	D	47/29/14.5	8-12
DRD960G34	3400	960	12	0.72	0.035	1500	1.7	G	58/34/26.5	12-18
DRD1830F34	3400	1830	23	2.65	0.02	1500	1.35	F	75/47/26.5	18-26
DRD2050X34	3400	2050	25.8	3.33	0.018	3000	1.55	X	85/53/26.5	26-34
DRD2980C34	3400	2980	36.5	6.66	0.0125	3000	1.35	C	100/63/26.5	40-50
DRD3920V34	3400	3920	49.5	12.25	0.01	3000	1.25	V	110/73/26.5	50-62
DRD5240W34	3400	5240	64.2	20.61	0.007	6000	1.29	W	120/84/26.5	62-78
DRD6140A34	3400	6140	84.4	35.62	0.0057	6000	1.1	A	150/100/35	80-100
DRD7810H34	3400	7810	118	69.62	0.004	6000	1.1	H	172/110/35	110-130
Up to 4000V										
DRD870G40	4000	870	15	1.13	0.032	1800	1.6	G	58.5/34/27	11.5-13.5
DRD1230F40	4000	1225	25	3.13	0.022	3400	1.6	F	76/48/27	18-22
DRD2960Y40	4000	2960	62.5	19.53	0.0095	3000	1.25	Y	112.5/73/37.7	38-47
DRD3390V40	4000	3388	62.5	19.53	0.0075	3000	1.25	V	112.5/73/27	38-47
DRD4350A40	4000	4350	83	34.50	0.007	3000	1.06	A	148/100/35	75-91
Up to 4400V										
DRA170E44	4400	170	1.5	0.01	0.115	300	2.1	E	42/25/15	2.5-3.8

Part Number	VRRM (V)	IF (AV) at TC = 100° (A)	IFSM at Tvj VR=0 (kA)	I ² t at Tvj VR = 0 (MA ² s)	Rth(j-c) (°C/W)	IFM (A)	VFM@ IFM & TC= 25°C (V)	Outline Type Code	Flange OD Contact OD Height (mm)	Clamping Force (kN) min - max
Up to 4500V										
DRD2000L45	4500	2000	31	3.075	0.013	3000	1.4	L	102/63/32.9	40-48
DRD6290H45	4500	6290	99.4	49.4	0.004	6000	1.19	H	172/110/35	110-130
Up to 4800V										
DRD1100F48	4800	1105	20.5	2.13	0.022	3400	1.8	F	76/48/27	18-22
Up to 5000V										
DRD710G50	5000	710	11.5	0.66	0.032	1800	1.8	G	58.5/34/ 27	11.5-13.5
DRD2690Y50	5000	2691	55	15.12	0.0095	3000	1.21	Y	112.5/73/37.7	38-47
DRD3080V50	5000	3083	55	15.12	0.0075	3000	1.21	V	112.5/73/27	38-47
5200V +										
DRD6010H52	5200	6015	111	39.6	0.0093	-	-	H	172/110/35	120-155
DRD5940H55	5500	5940	93.60	43.8	0.004	6000	1.26	H	172/110/36	110-130
DRD3770A52	5200	3768	70	24.50	0.0065	3000	1.17	A	148/100 /35.0	75-91
DRD3120B55	5500	3120	51.7	13.364	0.009	3000	1.31	B	120/78/35	62-78
DRD630G60	6000	630	10.5	0.555	0.032	1800	2.1	G	58.5/34/27	11.5-13.5
DRD1010F60	6000	1015	16.5	1.425	0.022	3400	2.1	F	76/48/27	18-22
DRD5150H65	6500	5150	82.5	34	0.004	6000	1.65	H	172/110/36	110-130
DRD4950H72	7200	4950	79	31.2	0.004	6000	1.71	H	172/110/36	110-130
DRD4690H85	8500	4690	74.5	27.75	0.004	6000	1.31	H	172/110/36	110-130
DRD560G90	9000	557	10	0.5	0.032	1200	2.08	G	58/34/26.5	11-13

Part Number	VRRM (V)	IF (AV) at TC = 100° (A)	IFSM at Tvj VR=0 (kA)	I ² t at Tvj VR = 0 (MA ² s)	Rth(j-c) (°C/W)	IFM (A)	VFM@ IFM & TC= 25°C (V)	Outline Type Code	Clamping Force (kN) min - max
S1104SXU30	3000	860	16	1.28	0.065	1800	1.225	S	0-22
S1107SXU40	4000	570	12	0.72	0.65	1800	1.55	S	0-22
S1109SXU50	5000	470	9.2	0.441	0.65	1800	2.1	S	0-22
S1112SXU60	6000	412	8.5	0.361	0.65	1800	2.6	S	0-22

Rectifier Diodes

The Dynex range of Rectifier Diodes convert AC to DC, and are suitable for industrial, chemical rectifiers and aluminium pot lines.

Key Features

- Current ratings from 410A average to 8800A average
- Voltage ratings from 1400V to 8500V
- High overload capability
- Low losses for high efficiency
- Hermetically sealed for long operational life
- Low thermal resistance

Fast Recovery Diodes

The Dynex range of Fast Recovery Diodes are designed to be used as snubber and anti-parallel diodes for use with its GTO.

Key Features

- Lifetime controlled for fast recovery, low recovery charge
- Low transient turn-on voltage
- High surge capability

Flat Base Rectifier Diodes

The Dynex range of Flat Base Rectifier Diodes convert AC to DC, for the refurbishment of industrial and chemical rectifiers and aluminium pot lines.

Key Features

- Current ratings of 470A average to 860A average
- Voltage ratings of 3kV to 4.8kV
- Low losses for high efficiency
- Hermetically sealed for long operational life
- Easily mounted down with M8 bolts on 46mm centres
- Available anode to base and cathode to base

Fast Recovery Diodes

Part Number	VRRM (V)	IT (AV) at TC= 65°C (A)	IFSM at Tvj VR=0 (kA)	I ² t at Tvj VR = 0 (MA ² s)	IFM (A)	VF (V)	Qr (μC)	t _{rr} (μs)	Outline Type Code	Flange OD Contact OD Height (mm)	Clamping Force (kN) min - max
Up to 1400V											
DF451	1600	295	3.5	0.061	600	2.65	25	1.22	T	42/19/15	4.5-5.5
Up to 2500V											
DSF8025SE	2500	650	7.5	0.281	1000	2.3	540	5	E	42/25/15	7-9
DF051	2500	1490	14	0.98	1500	1.85	800	5	F	75/47/27	21-25
Up to 4500V											
DSF8045SK	4500	430	3.5	0.061	1000	4	440	3.07	K	42/25/27	7-9
DSF20545SF	4500	1250	16	1.28	1800	2.1	1250	7	F	75/47/27	17.5-21.5
DSF21545SV	4500	3200	20	2	3000	2	1800	7	V	112.5/73/27	34-48
Up to 6000V											
DSF11060SG	6000	400	4.2	0.09	600	3.8	700	6	G	58/35/27	10.8-13.2



Explanation of Part Numbers

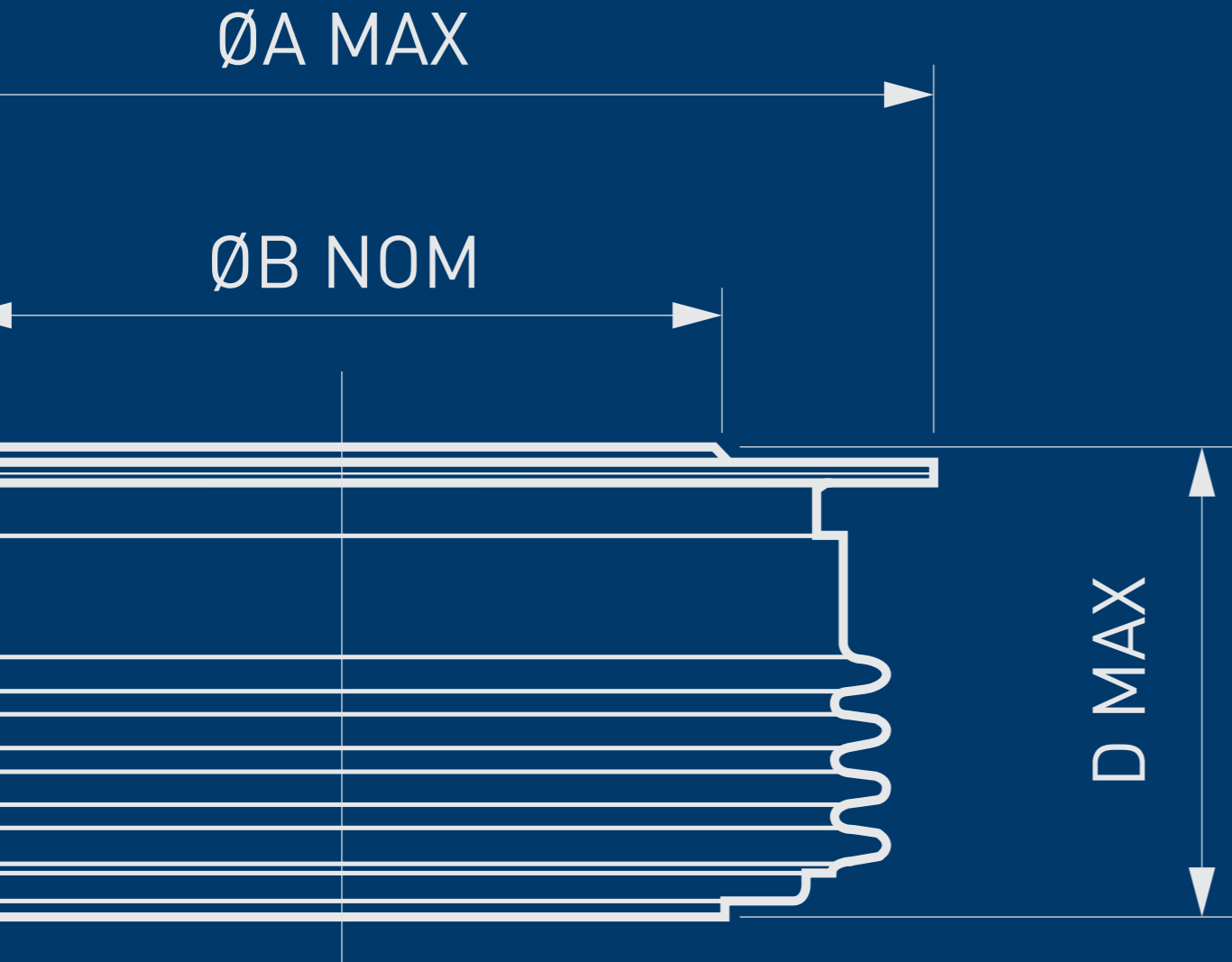

High Power IGBT & FRD Modules

Example Part Number: DFM800DDM18-A000

D	Dynex Semiconductor Identifier
I/F	I = IGBT / F = FRD
M	Module Generic Identifier
800	IC Current Rating
D/X/A/S/M	Package Outline/Power Terminal layout
D/S/C	Circuit configuration
S/M	Base plate technology S=Copper/M=Metal Matrix
18	Voltage rating divided by 100
(-)	
A/TS/TF/TL	Silicon Technology Identifier
US/UF/UL	
MS/MF/ML	
0	Special Selection Number (defaults to 000 for standard product)

***See page 29, 30, 31 for Package outlines**

Rectifier Diodes

Example Part Number: DRD2690Y50-1234

D	Dynex Semiconductor Identifier
RD	Rectifier Diode
2690	Average current rating at 100°C case temperature
Y	Case Outline
50	Vrrm/100
-1234	Special Selection Number

***See page 32 for Package outlines**

Gate Turn-off Thyristors

Example Part Number: DGT304SE13-123

D	Dynex Semiconductor Identifier
G	GTO
T	Optional indicates reverse blocking
30	Pellet size code
4	Factory code
S	Iteration A,B,C etc
E	Case Outline
13	Vdrm
-123	Special Selection Number

***See page 33 for Package outlines**

Asymmetric Thyristors

Example Part Number: ACR2900VR45-1234

A	Asymmetric
CR	Controlled Rectifier (Thyristor)
2900	Average current rating at 60°C case temperature
V	Case Outline
R/F	Reverse/Forward Blocking type
45	Vrrm /100 or Vdrm /100
-1234	Special Selection Number

***See page 32 for Package outlines**

Package Outlines

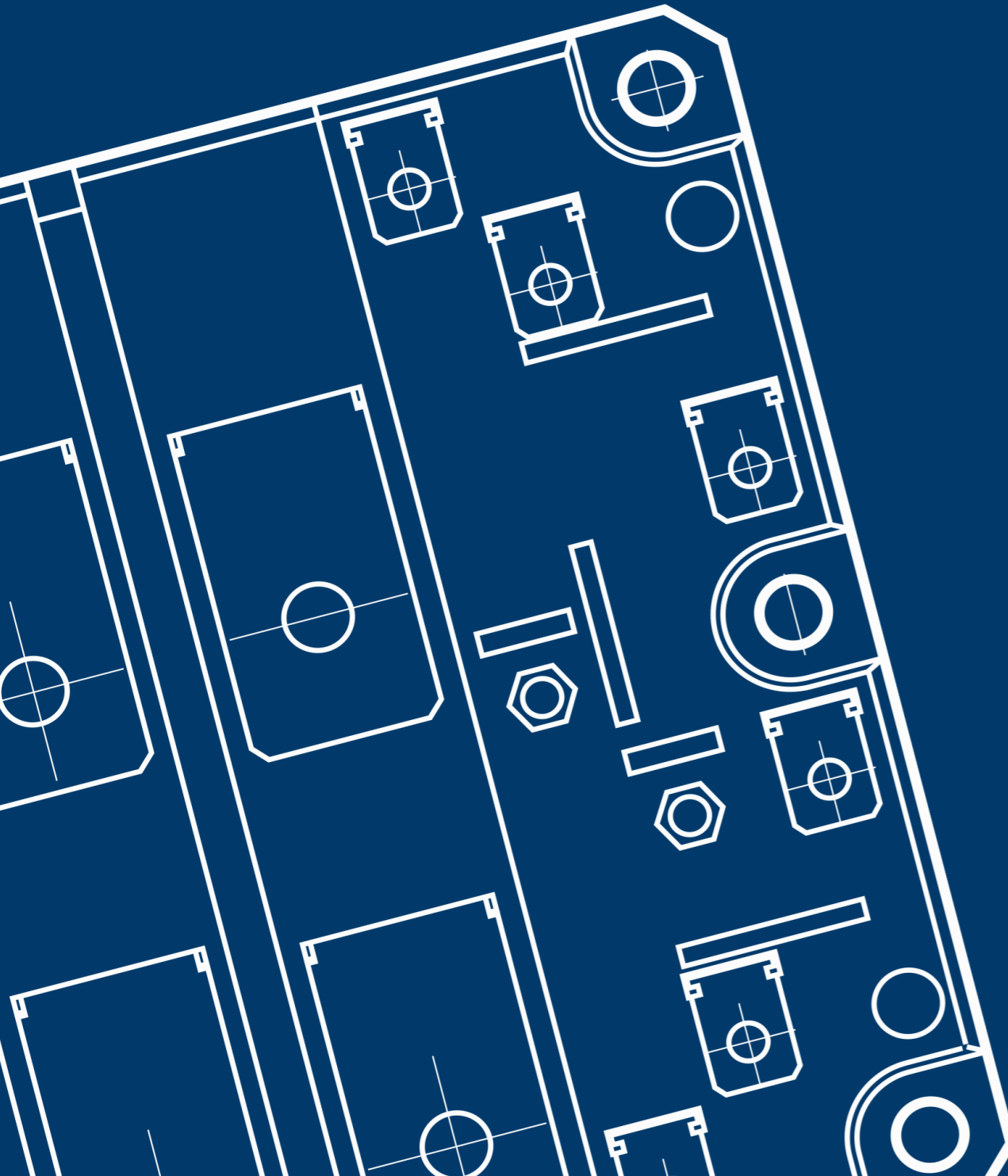

Module Outlines and Circuit Configurations
All dimensions shown in mm unless stated otherwise.

Package Type: D Nominal weight: 1000g/1600g

Dual Switch - DDM/S

C1 and C2 - Aux Collector
E1 and E2 - Aux Emitter
G1 and G2 - Gate

Chopper switch - DCM/S

Package Type: E Nominal weight: 1700g

Single Switch - ESM

3 - Aux Collector
2 - Gate
1 - Aux Emitter

Package Type: F Nominal weight: 1000g/1600g

Single Switch - FSM/S

C1 - Aux Collector
E1 - Aux Emitter
G1 - Gate

Package Type: N Nominal weight: 1000g

Single Switch - NSM

C1 - Aux Collector
E1 - Aux Emitter
G - Gate

Package Type: P Nominal weight: 500/750g

Bi-directional Switch - PBM

C1 - Aux Collector
E1 and E2 - Aux Emitter
G1 and G2 - Gate

Half Bridge - PHM

C1 - Aux Collector
E1 and E2 - Aux Emitter
G1 and G2 - Gate

Package Type: P Nominal weight: 500g

Chopper High Side - PKM

Chopper Low Side - PLM

Notes:
1. Mounting recommendations are given in the application note AN4505 'Heatsink Issues For IGBT Modules' available from our website.

Module Outlines and Circuit Configurations

All dimensions shown in mm unless stated otherwise.

Package Type: G

Nominal weight: 1000g

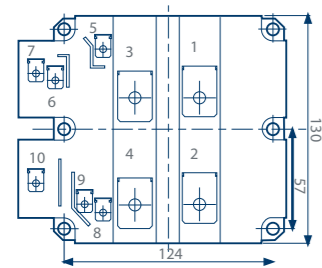

Dual Switch - GDM

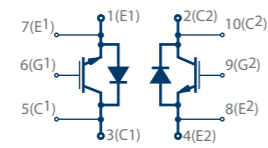

C1 and C2 - Aux Collector
E1 and E2 - Aux Emitter
G1 and G2 - Gate

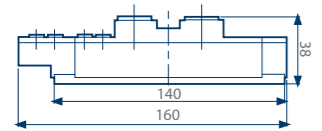

Chopper Switch - GCM

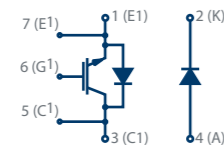

C1 and C2 - Aux Collector
E1 and E2 - Aux Emitter
G1 and G2 - Gate

Package Type: X

Nominal weight: 1100g

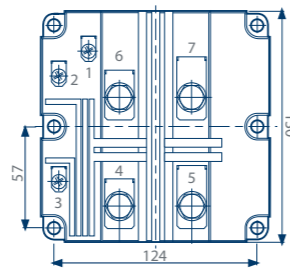

Single Switch - XSM

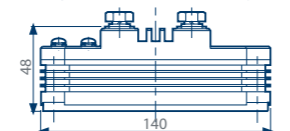
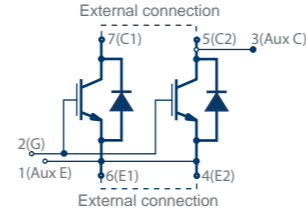

Chopper Switch - XCM

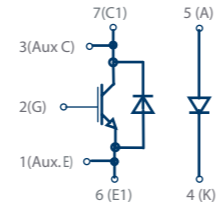

Package Type: A

Nominal weight: 1700g

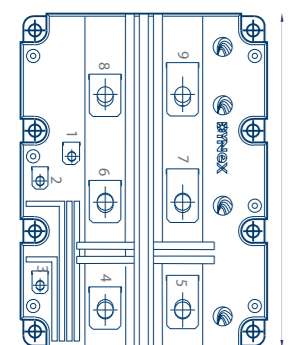

Single Switch - ASM

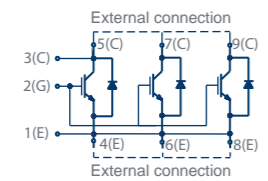

Chopper Switch - ACM

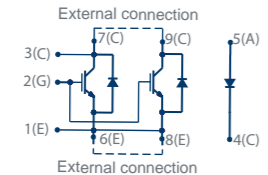

3 - Aux Collector
2 - Gate
1 - Aux Emitter

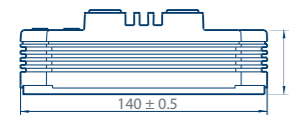

Module Outlines and Circuit Configurations

All dimensions shown in mm unless stated otherwise.

Package Type: E

Nominal weight: 1700g

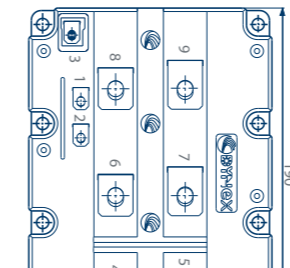

Triple Diode - EXM

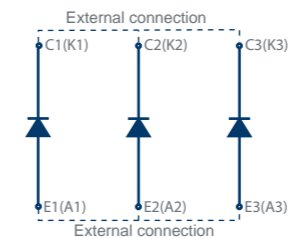

External connection for single diode application

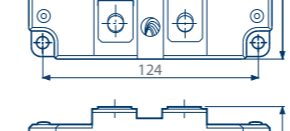

Package Type: X

Nominal weight: 1100g

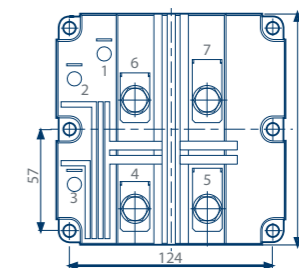

Dual Diode - XXM

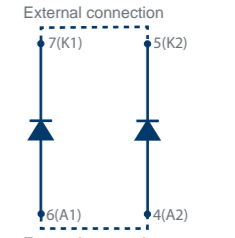

External connection for single diode application

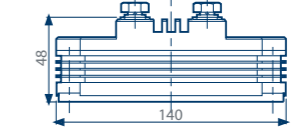

Package Type: F

Nominal weight: 1000g/1600g

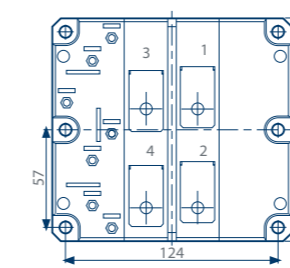

Dual Diode - FXM/S

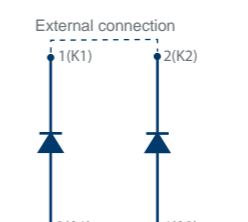

External connection for single diode application

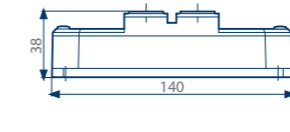

Package Type: N

Nominal weight: 1000g

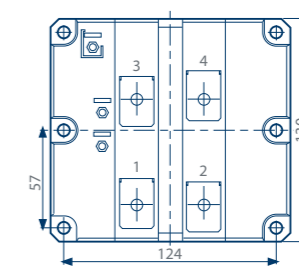

Dual Diode - NXM

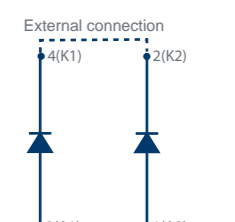

External connection for single diode application

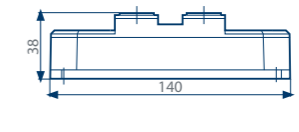

Package Type: P

Nominal weight: 500g

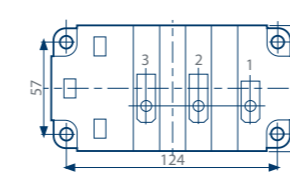

Series Diode - PXM

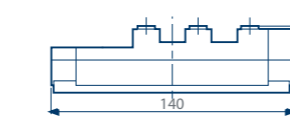

Notes:

1. Mounting recommendations are given in the application note AN4505 'Heatsink Issues For IGBT Modules' available from our website.

Notes:

1. Mounting recommendations are given in the application note AN4505 'Heatsink Issues For IGBT Modules' available from our website.

Thyristor and Diode Outlines

For detailed dimensions, see datasheet on www.dynexsemi.com

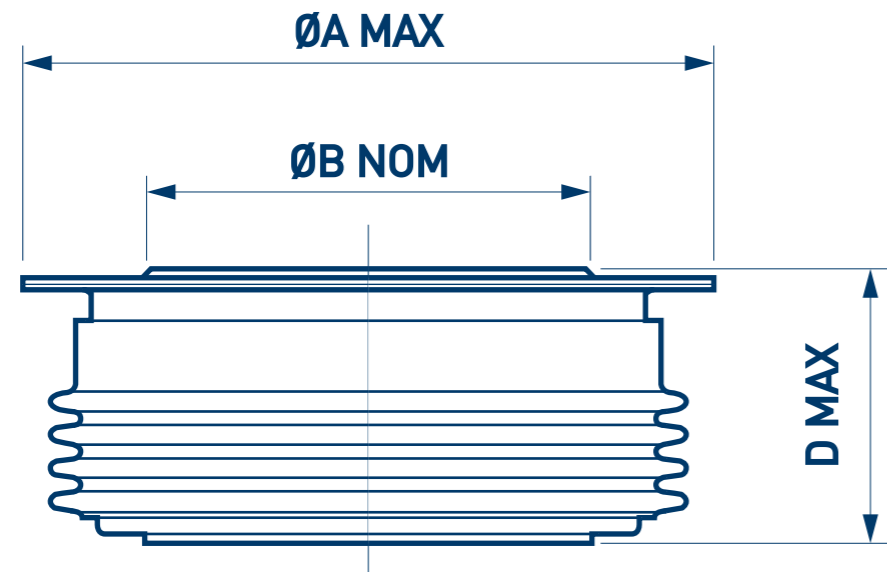

Outline	Flange (A) [mm] Max*	Pole (B) [mm] Nominal*	Depth (D) [mm] Maximum	Weight (kg)
A	148 & 150	100	37	2.6
B	120	85	36	1.5
C	99 & 102	63	28	0.8
D	47	29	15	0.24
E	42	25	15	0.082
F	73 & 75	47	28	0.433
G	57 & 58	35	28	0.25
H	172	110	36	3.5
J	57 & 58	34	36	0.322
K	42	25	27	0.16
L	99 & 100 & 102	63	36	1.05
M	148 & 150	100	27	1.95
N	73 & 75	47	36	0.48
T	42	19	15	0.055
V	110 & 112	73	29	1.1
W	120	84	29	1.55
X	85	53	27	0.6
Y	112 & 120	73 & 78	36	1.45

Notes:

*The character '&' denotes we manufacture products in a generic outline, some of which have one flange/contact diameter and others that have a slightly different flange/contact diameter. There is no choice of flange/contact diameter for a specific device.

GTO Outlines

For detailed dimensions, see datasheet on www.dynexsemi.com

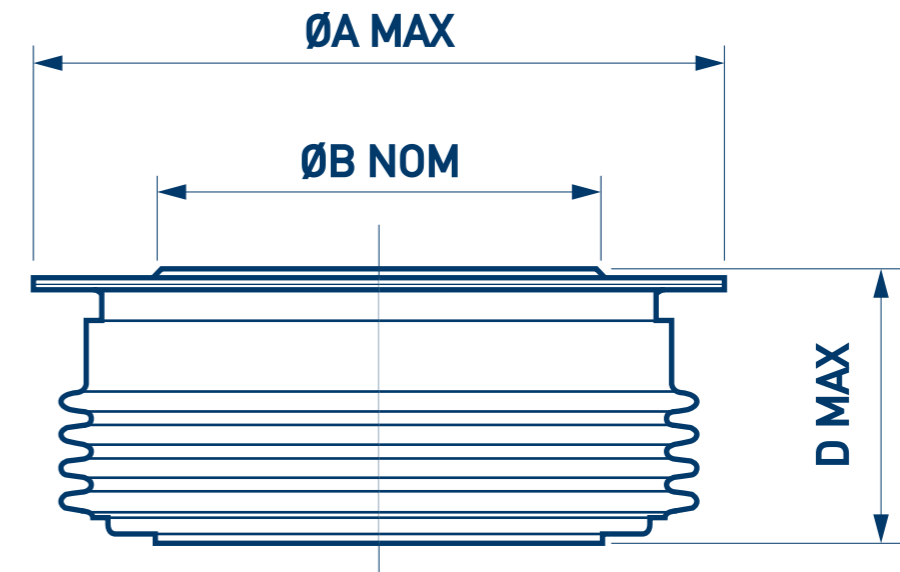

Outline	Flange/Max OD (A) [mm]	Pole (B) [mm]	Depth (D) [mm]	Weight (kg)
C	108	77	27	1.4
E	42	25	15	0.082
CA	56	38	36	0.46
H	100	63	27	0.82
P	56	38	27	0.35
W	120	85	27	1.7
v	85	53	27	1.2

Symbols and Definitions

C_S	Snubber capacitance	P_G	Gate power dissipation
di/dt	Critical rate of rise of on-state/forward current	P_{G(AV)}	Mean gate power dissipation
di_{FG}/dt	Rate of rise of positive gate current	P_{GM}	Peak gate power dissipation
di_{GO}/dt	Rate of rise of reverse gate current (GTO)	Q_r	Recovered charge
dIT/dt	Critical rate of rise of on-state current (GTO)	Q_{rr}	Reverse recovery charge
dsc	Double side cooled	r_T	On-state/forward slope resistance
dV/dt	Critical rate of rise of off-state voltage	R_{th(c-hs)}	Thermal resistance – case to heatsink
dV_b/dt	Rate of rise of off-state voltage (GTO)	R_{th(j-c)}	Thermal resistance – junction to case
E_{OFF}	Turn-off energy loss	R_{th(j-hs)}	Thermal resistance – junction to heatsink
E_{rec}	Reverse recovery energy	R_{th(j-w)}	Thermal resistance – junction to water
E_{sw(TOT)}	Total switching energy	T_c	Case temperature
F_m/F	Clamping force/mounting torque	t_{gq}	Gate controlled turn-off time
I²t	I ² t value	t_q	Turn-off time
I_C	Collector current	t_{rr}	Reverse recovery time
I_{C(PK)}	Peak collector current	T_{HS}	Heatsink temperature
I_{DRM}	On-state leakage current (thyristor)	T_{vj}	Virtual junction temperature
I_F	Forward current (diode)	T_{vjm}	Maximum virtual junction temperature
I_{F(AV)}	Mean forward current (diode)	T_{water}	Water temperature
I_{FM}	Peak forward current (diode)	V_{CE(sat)}	Collector-emitter saturation voltage (IGBT)
I_{F(RMS)}	RMS forward current (diode)	V_{CES}	Collector-emitter voltage (IGBT)
I_{FSM}	Single cycle surge current (diode), (10ms half sinewave)	V_{DRM}	Repetitive peak off-state voltage
I_{G(ON)}	Gate turn-on current (GTO)	V_{DSM}	Non-repetitive peak off-state voltage
I_{GT}	Gate trigger current	V_F	Forward voltage (diode)
I_{RMS}	RMS line current	V_{FM}	Peak forward voltage (diode)
I_{PK}	Peak current	V_{isol}	Isolation voltage
I_{RRM}	Peak reverse recovery current	V_{GT}	Gate trigger voltage
I_{T(RMS)}	RMS on-state current (thyristor)	V_R	Reverse voltage
I_{T/ITM}	On-state current	V_{RRM}	Repetitive peak reverse voltage
I_{T(AV)}	Mean on-state current (thyristor)	V_{RSM}	Non-repetitive peak reverse voltage
I_{TCM}	Maximum repetitive controllable current (GTO)	V_T	On-state voltage
I_{TSM}	Single cycle surge current (thyristor), (10ms half sinewave)	V_{TM}	Peak on-state voltage
		V_{TO}	Threshold voltage (diode)
		V_{T(TO)}	Threshold voltage (thyristor)

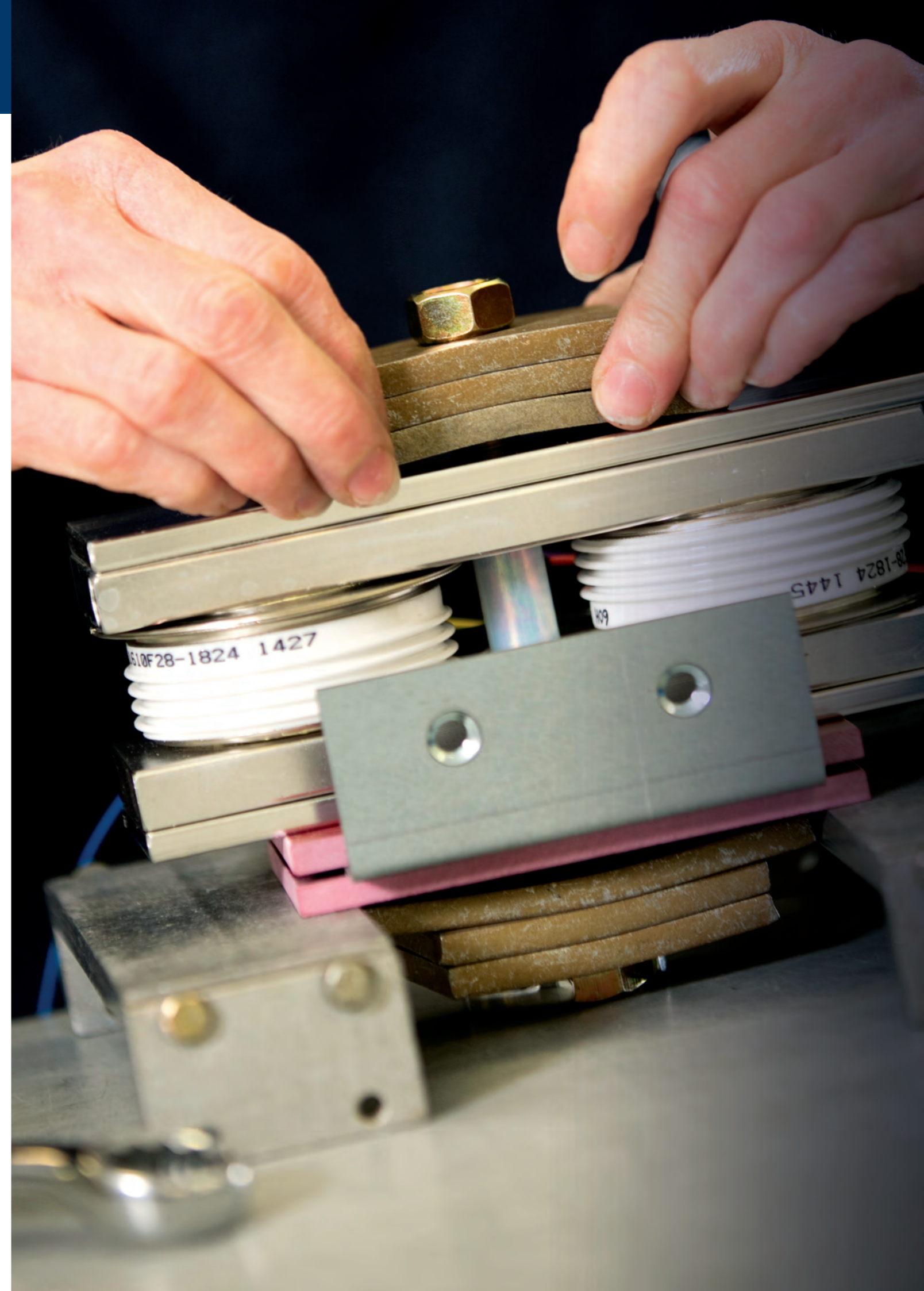

Important Information

The products and information in this publication are intended for use by appropriately trained technical personnel. Due to the diversity of product applications, the information contained herein is provided as a general guide only and does not constitute any guarantee of suitability for use in a specific application. The user must evaluate the suitability of the product and the completeness of the product data for the application. The user is responsible for product selection and ensuring all safety and any warning requirements are met. Should additional product information be needed please contact our Customer Service team. Although we have endeavoured to carefully compile the information in this publication it may contain inaccuracies or typographical errors. The information is provided without any warranty or guarantee of any kind.

This publication is an uncontrolled document and is subject to change without notice. When referring to it please ensure that it is the most up to date version and has not been superseded. The products are not intended for use in medical or other applications where a failure or malfunction may cause loss of life, injury or damage to property. The user must ensure that appropriate safety precautions are taken to prevent or mitigate the consequences of a product failure or malfunction. The products must not be touched when operating because there is a danger of electrocution or severe burning. Always use protective safety equipment such as appropriate shields for the product and wear safety glasses. Even when disconnected any electric charge remaining in the product must be discharged and allowed to cool before safe handling using protective gloves. Extended exposure to conditions outside the product ratings may affect reliability leading to premature product failure. Use outside the product ratings is likely to cause permanent damage to the product. In extreme conditions, as with all semiconductors, this may include potentially hazardous rupture, a large current to flow or high voltage arcing, resulting in fire or explosion. Appropriate application design and safety precautions should always be followed to protect persons and property.

Product Status and Product Ordering:

We annotate datasheets in the top right hand corner of the front page, to indicate product status if it is not yet fully approved for production. The annotations are as follows:

Target Information:

This is the most tentative form of information and represents a very preliminary specification. No actual design work on the product has been started.

Preliminary Information:

The product design is complete and final characterisation for volume production is in progress. The datasheet represents the product as it is now understood but details may change.

No Annotation:

The product has been approved for production and unless otherwise notified by Dynex any product ordered will be supplied to the current version of the data sheet prevailing at the time of our order acknowledgement.

All products and materials are sold and services provided subject to Dynex's conditions of sale, which are available on request.

Any brand names and product names used in this publication are trademarks, registered trademarks or trade names of their respective owners.

Warning Counterfeit Products:

There are counterfeit products on the semiconductor marketplace. Unfortunately, many of these products will have markings and labels that closely resemble those from Dynex's genuine products, making it difficult to realise the difference. Dynex has extensive, proven controls to ensure its products are properly manufactured, tested, handled, and stored to prevent failures. Counterfeit products will not have been subjected to these processes. Therefore, Dynex does not warrant any parts purchased through unauthorised channels nor do we accept any liability for failure of counterfeit products.

Dynex's Advice to customer is as follows:

Only purchase from Dynex directly or from one of Dynex's authorised distributors. Our Customer Services team can advise you whether a distributor is authorised via the details below.

Dynex products should not be purchased if the outer appearance differs from Dynex products you normally receive unless Dynex or a Dynex authorised distributor has provided you with a product change notification or can be seen on datasheets from the Dynex Website. We strongly advise against purchasing extraordinarily low priced Dynex products from unauthorised distributors. Dynex does not support the sale of Dynex products via online auction houses. We will be pleased to confirm the authenticity of the products. To do so please contact Dynex's Customer Services (see reverse for contact information) with the following information:

- Part number, quantity purchased, unit cost
- Name and contact name of the supplier with address, phone, and web/e-mail addresses
- Digital photos of inner and outer label, inner and outer packaging, and front and back of product

- Copy of purchase order and invoice

This is intended to provide you with additional information on counterfeiting and steps that can be taken to better recognize counterfeit products.

www.dynexsemi.com

powersolutions@dynexsemi.com

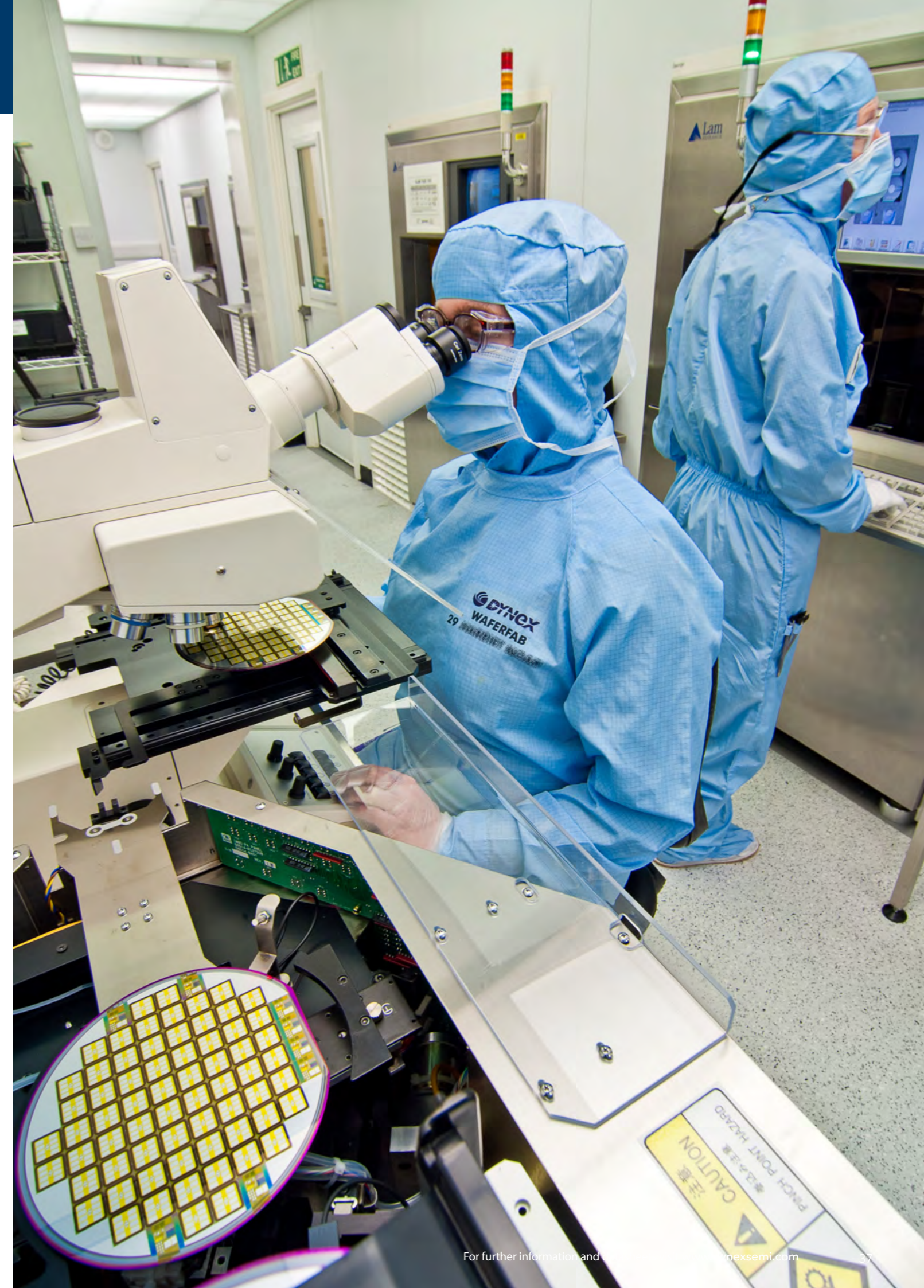



Dynex Semiconductor Ltd
Doddington Road
Lincoln
LN6 3LF
United Kingdom

Email: powersolutions@dynexsemi.com
Main switchboard: +44 (0)1522 500 500

 @Dynexpower

 Dynex Semiconductor Ltd

DYN-PS-19003